

LUXEON Altilon SMD 1x4

Industry leading solutions for exterior automotive lighting

LUXEON Altilon SMD 1x4 LEDs are designed to support low and high beam, daytime running lamps and front fog applications. The Lumileds automotive binning structure meets both, SAE and ECE color specifications, and is hot binned at 85°C, consistent with current automotive operating environments. LUXEON Altilon SMD 1x4 LEDs are AEC-Q102 qualified.

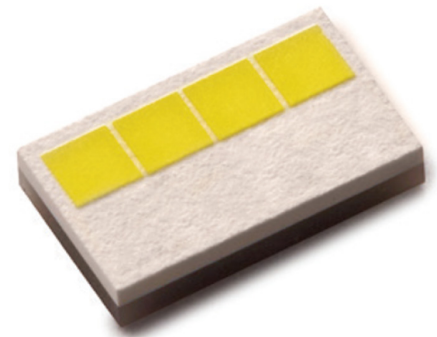
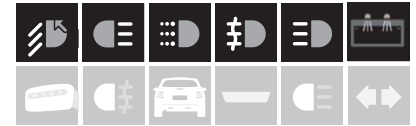

FEATURES AND BENEFITS

- Higher drive current capability for increased flux performance
- High flux output provides flexibility in styling and optical design
- Compact, robust design with thermal solder pad enables best thermal performance on a wide variety of PCB types
- Low thermal resistance and power consumption results in simplified thermal management and system cost
- Advanced CSP technology provides leading performance in a cost effective package
- Hot binned at 85°C MP to match operating conditions
- EC/PAS 62707-1 White LED

PRIMARY APPLICATIONS

- Daytime Running Lights
- Low and High Beam
- ADB (Adaptive Driving Beam)
- AFS (Advanced Front Lighting Systems)
- Cornering Lights
- Fog Lights
- License plate and Back up Lights
- Reverse

Table of Contents

General Product Information	2
Product Test and Binning Conditions	2
Part Number Nomenclature	2
Environmental Compliance	2
Performance Characteristics	3
Product Selection Guide	3
Optical Characteristics	3
Electrical and Thermal Characteristics	3
Absolute Ratings	4
Characteristic Curves	4
Spectral Power Distribution Characteristics	4
Light Output Characteristics	5
Forward Current and Voltage Characteristics	6
Color Shift Characteristics	7
Radiation Pattern Characteristics	8
Operating Limits Characteristics	9
Pulse Handling Capability	10
Product Bin and Labeling Definitions	11
Decoding Product Bin Labeling	11
Luminous Flux Bins	11
Color Bin Definition	12
Color Codes	12
Forward Voltage Bins	14
Mechanical Dimensions	15
Package Weight	15
JEDEC Moisture Sensitivity	15
Packaging Information	16
Pocket Tape Dimensions	16
Reel Dimensions	16
Product Labeling	17

General Product Information

LUXEON Altilon SMD 1x4 emitters are high-power Lumiramic© Phosphor converted InGaN emitters mounted on an AlN package. All LUXEON Altilon SMD 1x4 emitters contain a TVS chip for ESD protection.

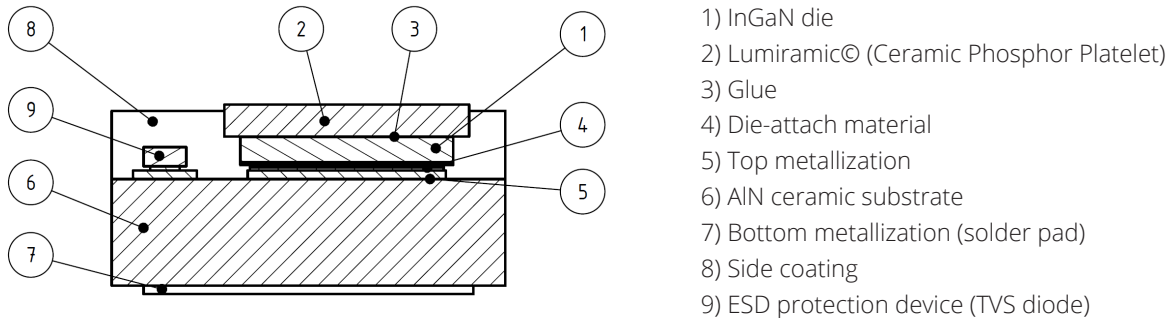

Figure 1. Schematic cross section LUXEON Altilon SMD 1x4

Product Test and Binning Conditions

Monopulse (MP) testing for LUXEON Altilon SMD 1x4 is done with a pulse of 1 ms. The binning conditions for LUXEON Altilon SMD 1x4 are MP testing at 1000 mA at a temperature of 85 °C.

Part Number Nomenclature

Part numbers for LUXEON Altilon SMD 1x4 follow the convention below:

A 1 S C – B B B B C D E F G G G G H

Where:

- B B B B – Designates the correlated color temperature (5850 = Cool White)
- C – Designates number of die (4 = 4 die)
- D – Designates test current (D = 1000 mA)
- E – Designates test temperature (H = 85 °C)
- F – Designates product generation (2 = Gen8)
- G G G G – Designates minimum luminous flux (example: 1600 = 1600 lumens)
- H – Designates options code for distribution (default = 0)

Therefore, the following part number is used for a LUXEON Altilon SMD 1x4 with a minimum luminous flux of 1600 lumens:

A 1 S C – 5 8 5 0 4 D H 2 1 6 0 0 0

Environmental Compliance

Lumileds LLC is committed to providing environmentally friendly products to the solid-state lighting market. LUXEON Altilon SMD 1x4 is compliant to the European Union directives on the restriction of hazardous substances in electronic equipment, namely the RoHS Directive 2011/65/EU and REACH Regulation (EC) 1907/2006. Lumileds LLC will not intentionally add the following restricted materials to its products: lead, mercury, cadmium, hexavalent chromium, polybrominated biphenyls (PBB) or polybrominated diphenyl ethers (PBDE).

Performance Characteristics

Product Selection Guide

Table 1. Product performance and optical characteristics of LUXEON Altilon SMD 1x4 at MP binning conditions

MINIMUM LUMINOUS FLUX ^[1] (lm)	PART NUMBER
1360	A1SC-58504DH213600
1400	A1SC-58504DH214000
1440	A1SC-58504DH214400
1480	A1SC-58504DH214800

Notes for Table 1:

1. Lumileds maintains a tolerance of $\pm 6,5\%$ on luminous flux measurements.

Optical Characteristics

Table 2. Optical characteristics for LUXEON Altilon SMD 1x4 at MP binning conditions and far-field optical characteristics

PART NUMBER	CORRELATED COLOR TEMPERATURE		TYPICAL TOTAL INCLUDED ANGLE ^[1] $\theta_{0.90V}$	TYPICAL VIEWING ANGLE ^[2] $\theta_{1/2}$
	MINIMUM	MAXIMUM		
A1SC-58504DH2xxxxx	5180K	6680K	140°	120°

Notes for Table 2:

1. Total angle at which 90% of total luminous flux is captured.
2. $2\theta_{1/2}$ denotes the viewing angle, with $\theta_{1/2}$ being the off-axis angle from the LED centerline where the luminous intensity is $\frac{1}{2}$ of the peak value.

Electrical and Thermal Characteristics

Table 3. Electrical and thermal characteristics for LUXEON Altilon SMD 1x4. Electrical characteristics at MP binning condition, thermal characteristics at binning current and 25°C stage temperature

PART NUMBER	FORWARD VOLTAGE (V_f) ^[1] [V]			THERMAL RESISTANCE— JUNCTION TO CASE (K/W)			
	MIN.	TYP.	MAX.	$R\theta_{jc\ el}$ ^[2]		$R\theta_{jc\ real}$ ^[3]	
				TYPICAL	MAXIMUM	TYPICAL	MAXIMUM
A1SC-58504DH2xxxxx	11.60	12.39	13.40	1.3	1.5	2.2	2.5

Notes for Table 3:

1. Lumileds maintains a tolerance of $\pm 0.06V$ on forward voltage measurements.
2. Ratio between temperature difference (junction to case) and electrical input power (references JESD51-51, JESD51-14).
3. Ratio between temperature difference (junction to case) and dissipated heat, i.e. emitted light taken into account (references JESD51-51, JESD51-14).

Absolute Ratings

Table 4. Absolute ratings for LUXEON Altilon SMD 1x4

PARAMETER	PERFORMANCE
Minimum DC Forward Current	50 mA
Maximum DC Forward Current ^[1]	1500 mA
Maximum Peak Pulsed Forward Current ^[1]	2500 mA
Maximum Emitter Junction Temperature ^[1] (DC & Pulse)	150 °C
Maximum Emitter Junction Temperature ^[1, 2] (DC & Pulse), short term	180 °C
ESD Sensitivity ^[3]	HBM ±8 kV CDM ±2 kV
Operating Case Temperature ^[1]	-40 °C to 135 °C
Emitter Storage Temperature	-40 °C to 135 °C
SMD Process Classification Temperature	260 °C
Allowable Reflow Cycles	3
Reverse Voltage (Vreverse)	Not designed to be driven in reverse bias

Notes for Table 4:

1. Proper current derating must be observed to maintain the junction temperature below the maximum allowable junction temperature.
2. Short time operations of less than 200 hours,
3. Measured using human body model (per ANSI/ANSI/ESDA/JEDEC JS-001-2010), charged device model (AEC Q101-005 rev A).

Characteristic Curves

Spectral Power Distribution Characteristics

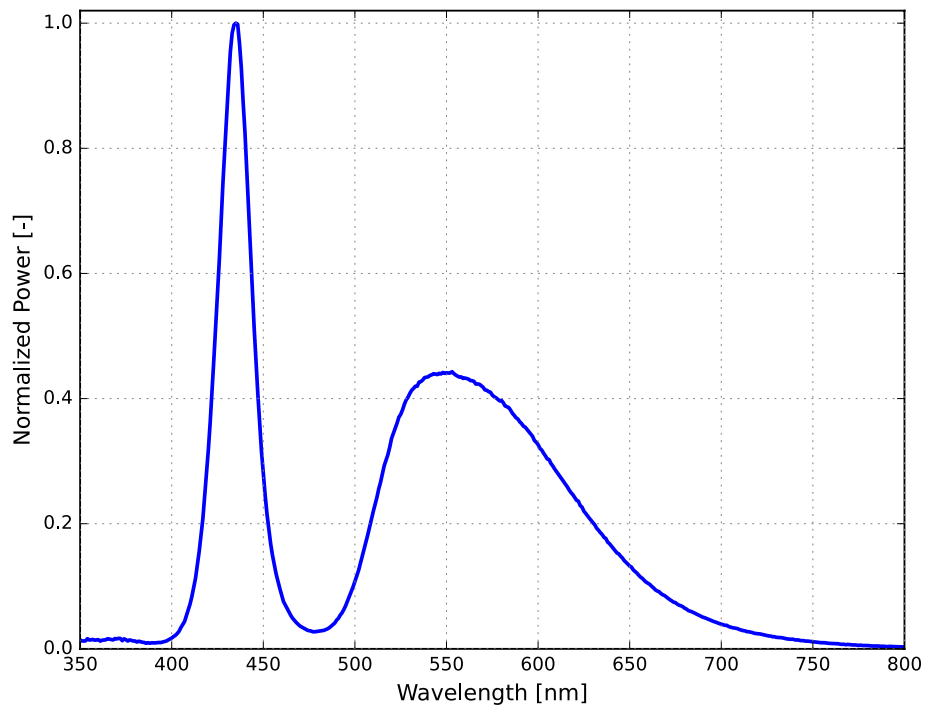

Figure 2. Typical normalized power vs. wavelength for LUXEON Altilon SMD 1x4 at MP binning conditions

Light Output Characteristics

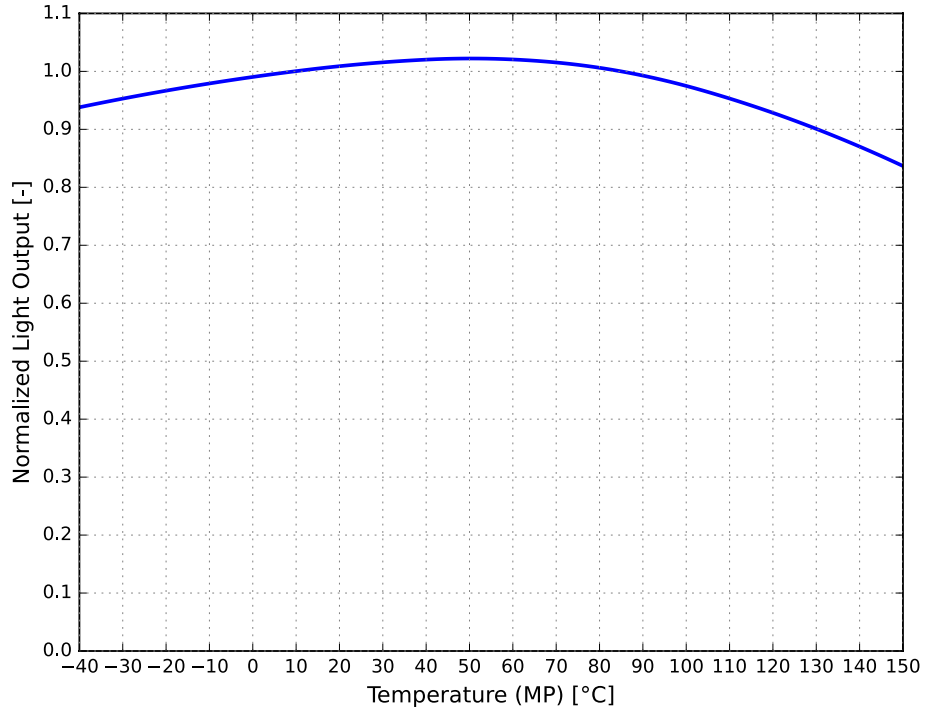

Figure 3. Typical normalized light output vs. temperature for LUXEON Altilon SMD 1x4 at MP binning current

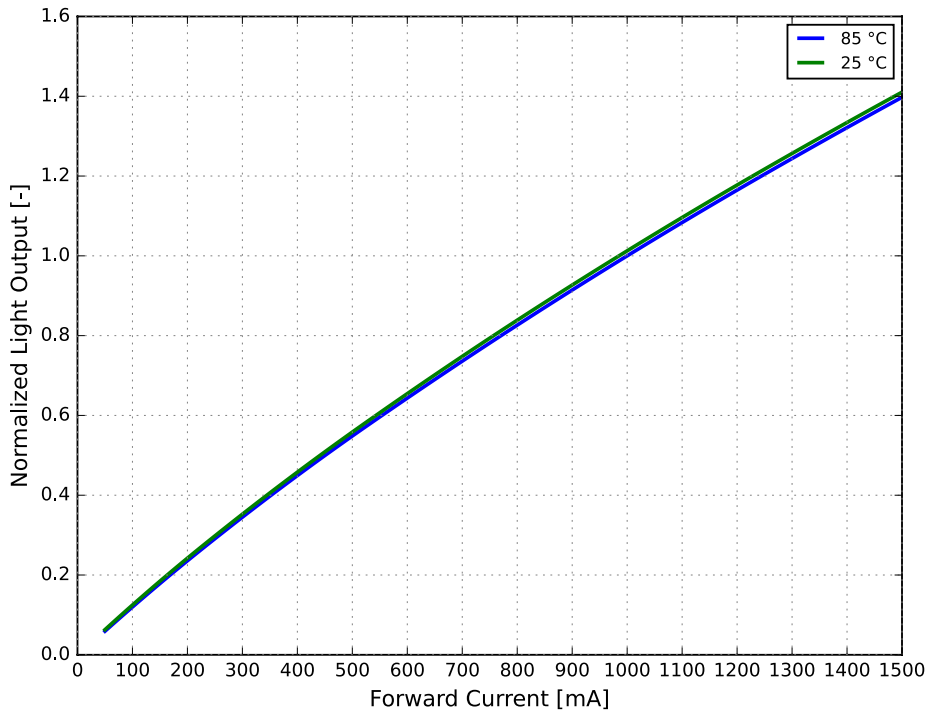

Figure 4. Typical normalized light output vs. forward current for LUXEON Altilon SMD 1x4 at MP binning temperature and at room temperature

Forward Current and Voltage Characteristics

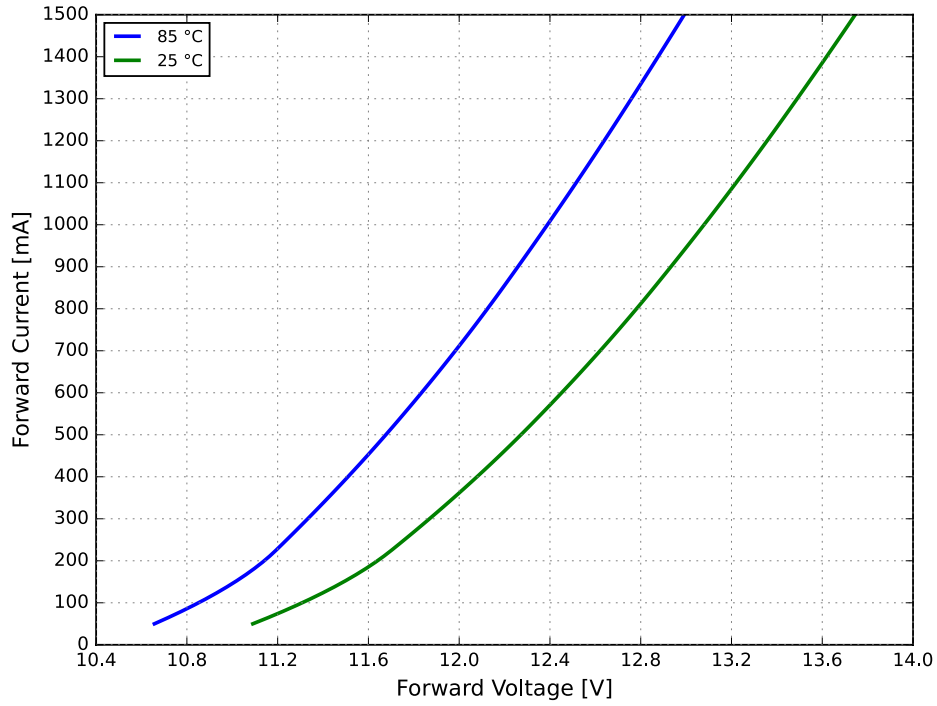

Figure 5. Typical forward current vs. forward voltage for LUXEON Altilon SMD 1x4 at MP binning temperature and at room

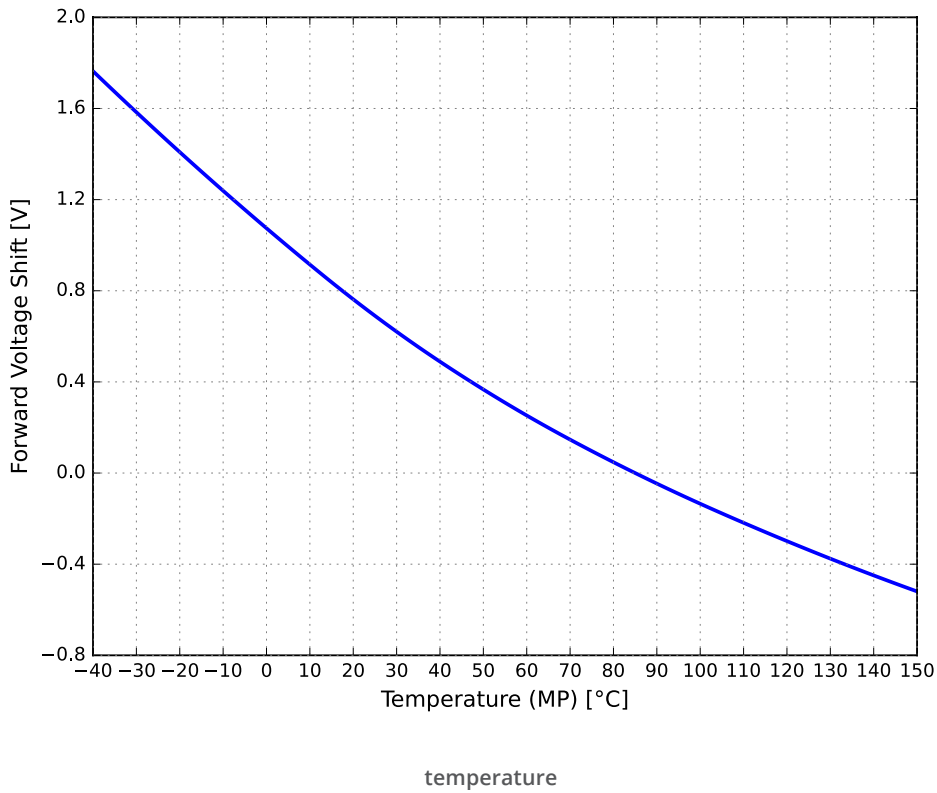

Figure 6. Typical forward voltage shift vs. temperature for LUXEON Altilon SMD 1x4 at MP binning current

Color Shift Characteristics

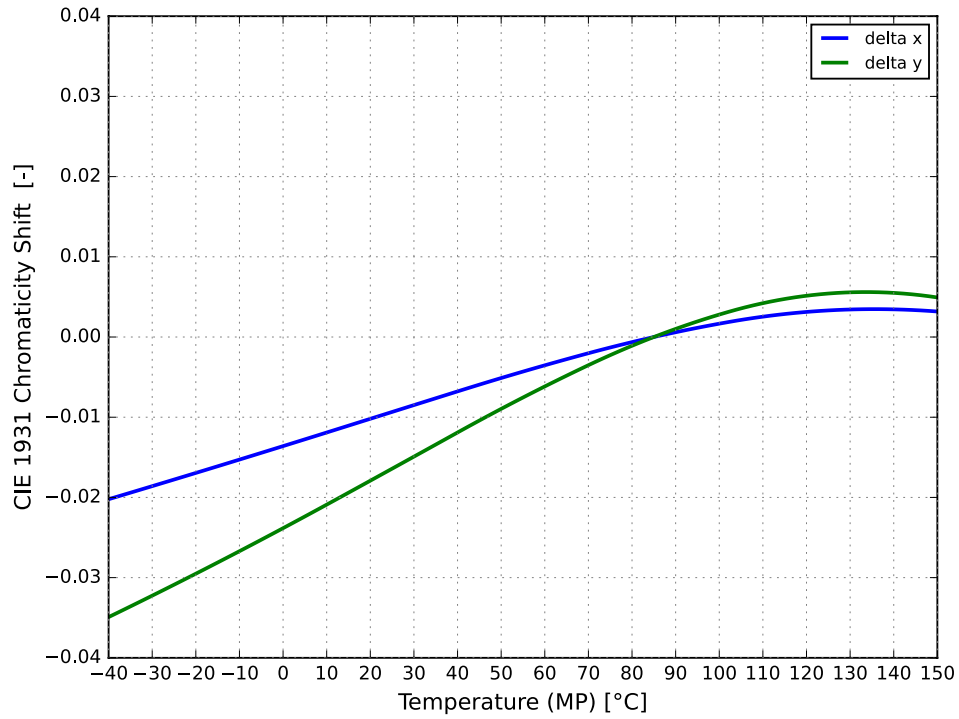

Figure 7. Typical color shift in CIE 1931 x, y coordinates vs. temperature for LUXEON Altilon SMD 1x4 at MP binning current

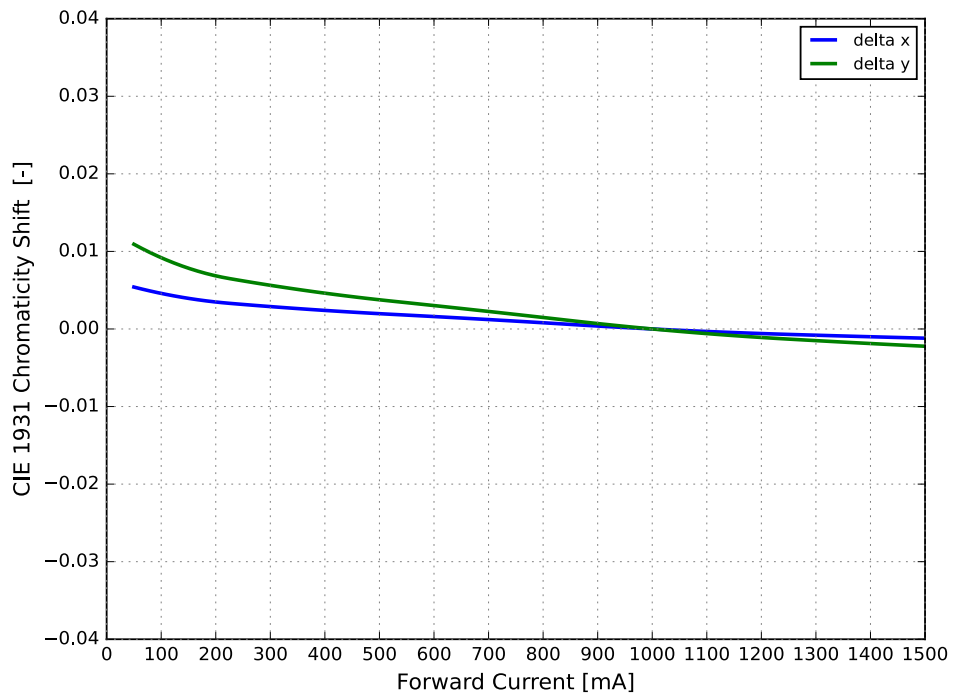

Figure 8. Typical color shift in CIE 1931 x, y coordinates vs. forward current for LUXEON Altilon SMD 1x4 at MP binning temperature

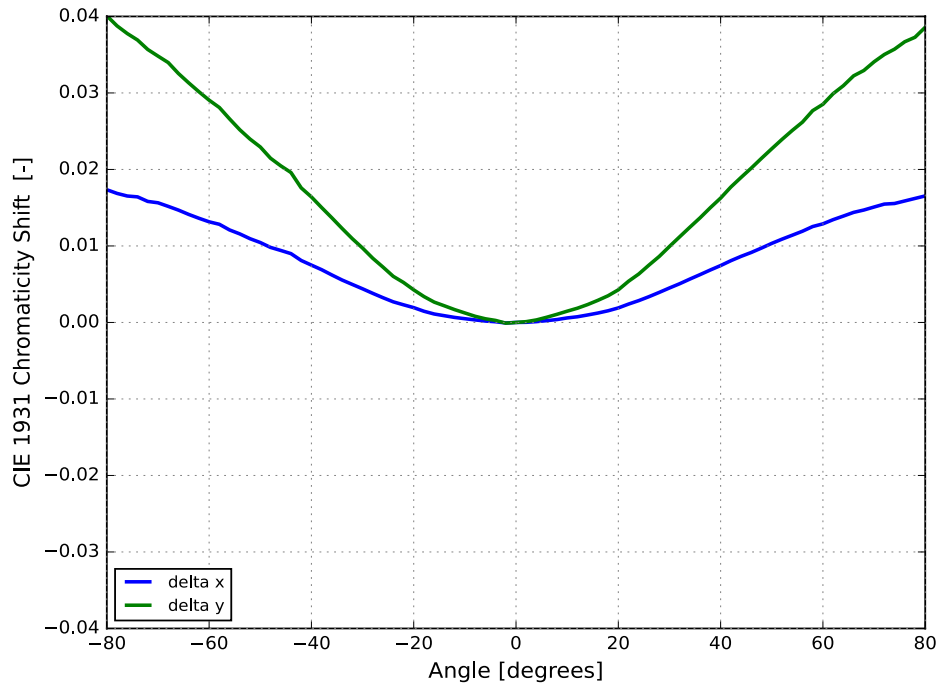

Figure 9. Typical color shift over angle for LUXEON Altilon SMD 1x4

Radiation Pattern Characteristics

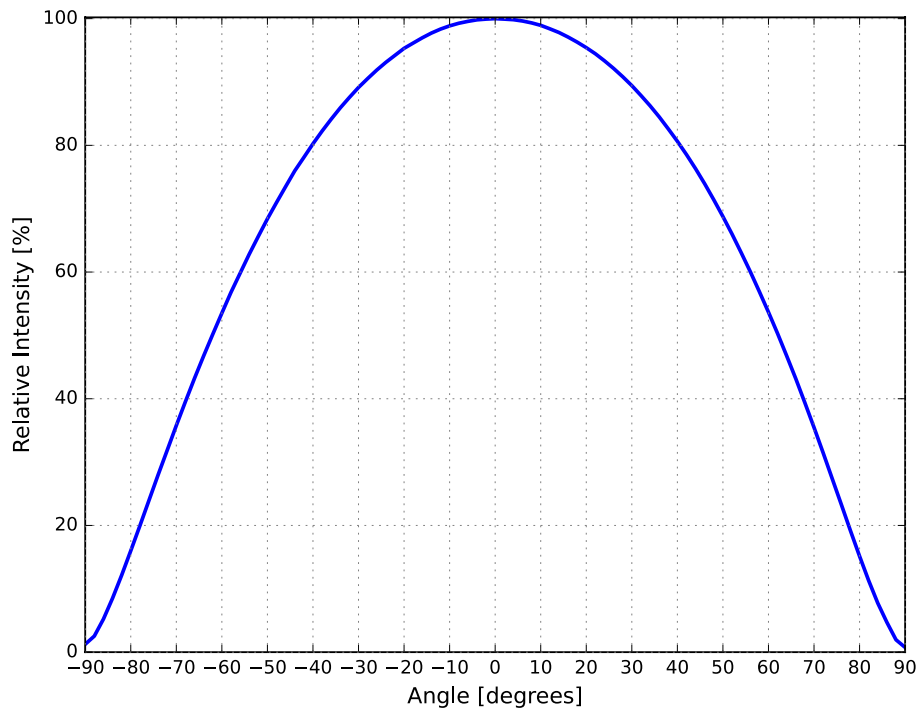

Figure 10. Typical Radiation Pattern for LUXEON Altilon SMD 1x4

Operating Limits Characteristics

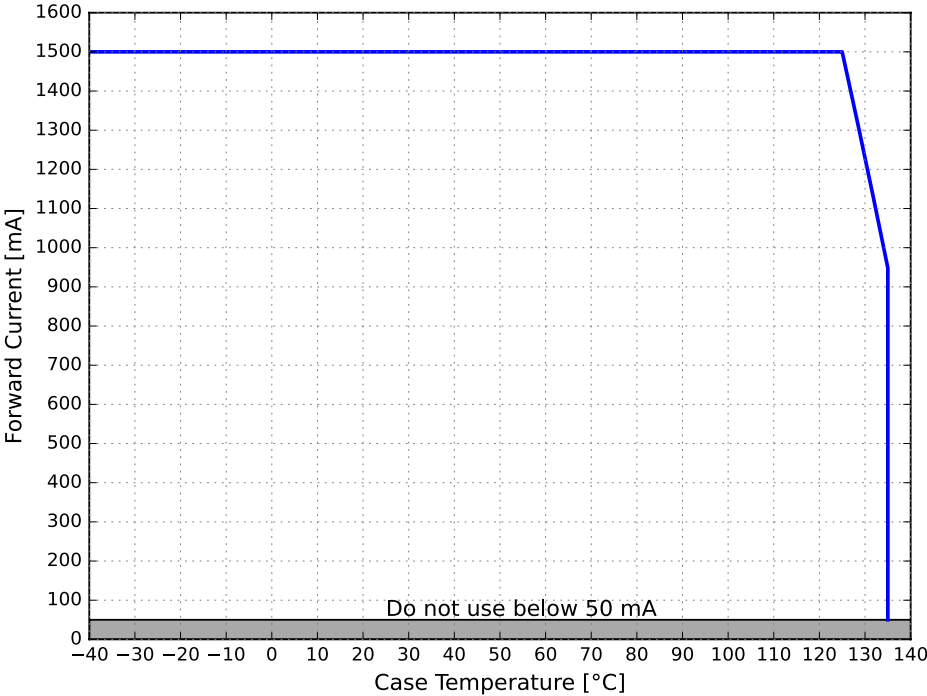

Figure 11. Maximum forward current vs. case temperature for LUXEON Altilon SMD 1x4

Pulse Handling Capability

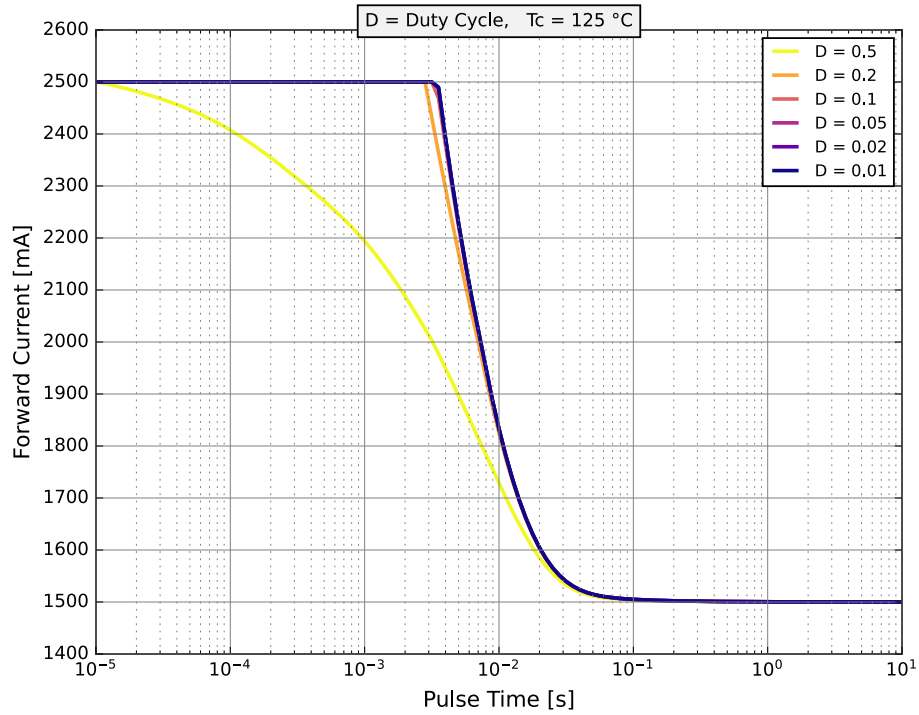

Figure 12a. Pulse handling capability for LUXEON Altilon SMD 1x4 at highest case temperature, where maximum DC current can be applied

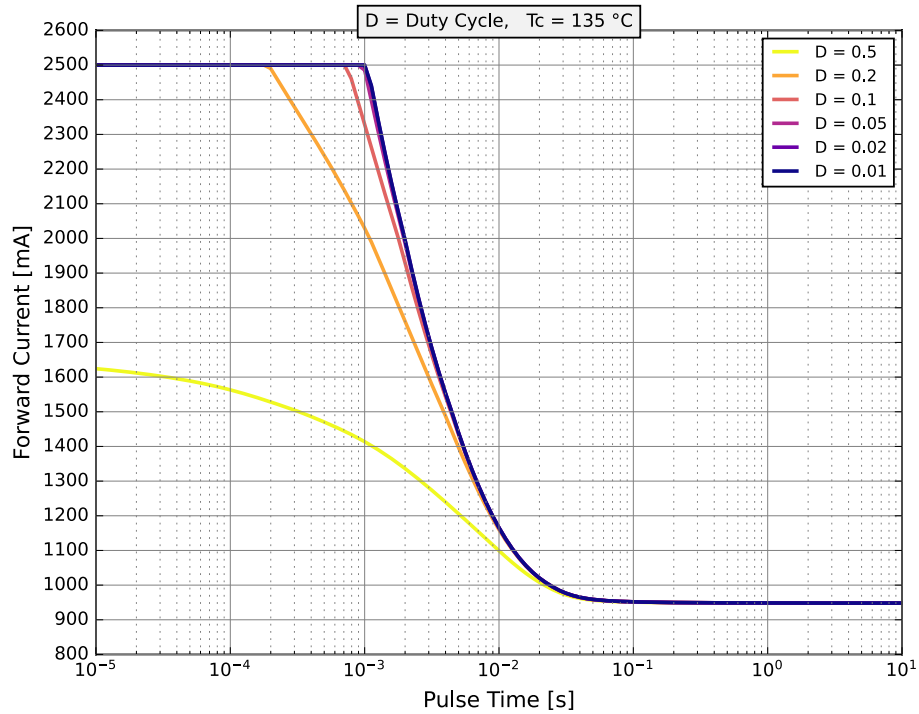

Figure 12b. Pulse handling capability for LUXEON Altilon SMD 1x4 at maximum case temperature

Product Bin and Labeling Definitions

Decoding Product Bin Labeling

In the manufacturing of semiconductor products, there are variations in performance around the average values given in the technical datasheets. For this reason, Lumileds bins the LED components for luminous flux or radiometric power, forward voltage, color point, peak wavelength, or dominant wavelength.

The CAT code identifies the flux and color bin of each part. The CAT code can be found in two distinct places, the package label and the TnR label. LUXEON Altilon SMD LEDs are labeled using a 4-digit alphanumeric CAT code following the format below:

A B C D

Where:

- A** – designates the luminous flux bin per die (example: Q = 370 to 380 lumens per die)
- B C** – designates color bin (example: HC)
- D** – designates forward voltage bin (example: X = 11.60 V to 13.40 V)

Therefore, a LUXEON Altilon SMD 1x4 emitter with a lumen range of 1480 to 1520 lumens, color code HC and a forward voltage of 11.60 V to 13.40V has the following CAT code:

Q H C X

Luminous Flux Bins

Table 5 lists the standard luminous flux bins for LUXEON Altilon SMD 1x4 emitters. Although several bins are outlined, product availability in a particular bin varies by production run and by product performance.

The total flux is derived from the flux per die multiplied by the number of die, therefore the total flux of a device with four die and bin Q will be in the range of 1480 to 1520 lumens.

This will allow for better flux bin granularity, as a 1x2 will have 20 lm flux bin increments, a 1x3 30 lm, a 1x4 40 lm and a 1x5 50 lm. The flux bin is defined on the total flux of the device as die are not individually measured.

Table 5. Luminous flux bin definitions for LUXEON Altilon SMD 1x4 at MP binning conditions

BIN	LUMINOUS FLUX ^[1] (lm) per die		TOTAL LUMINOUS FLUX ^[1] (lm)	
	MINIMUM	MAXIMUM	MINIMUM	MAXIMUM
M	340	350	1360	1400
N	350	360	1400	1440
P	360	370	1440	1480
Q	370	380	1480	1520
R	380	390	1520	1560
S	390	400	1560	1600
T	400	410	1600	1640

Notes for Table 5:

1. Lumileds maintains a tolerance of ±6.5% on luminous flux measurements.

Color Bin Definition

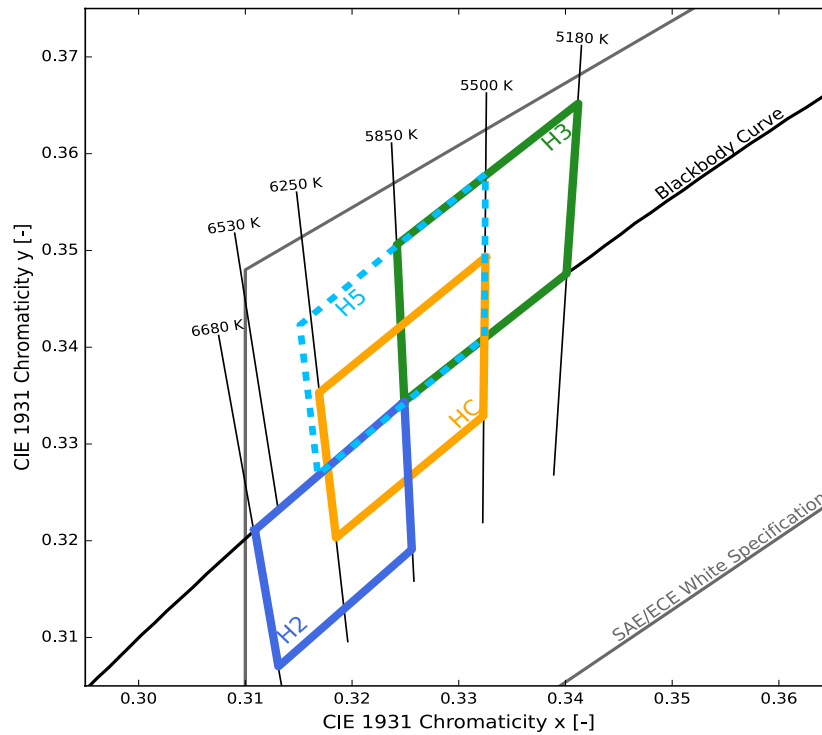

Figure 13. Color bin structure for LUXEON Attilon SMD 1x4

Notes for Figure 13:

1. Lumileds supports the following bins for LUXEON Attilon SMD 1x4: H2, H3, HC, H5

Color Codes

Table 6. Color bin definitions for LUXEON Attilon SMD 1x4 at MP binning conditions

BIN	$x^{[1,2]}$	$y^{[1,2]}$	6-DIGIT IEC CODE	TYPICAL CCT
HC	0.3325	0.3493	ebyD66	5850 K
	0.3169	0.3353		
	0.3185	0.3203		
H5	0.3323	0.3329	NA	5900 K
	0.3325	0.3579		
	0.3151	0.3423		
H2	0.3168	0.3268	ebvG66	6250 K
	0.3324	0.3410		
	0.3109	0.3211		
H3	0.3131	0.3070	fcbA66	5500 K
	0.3256	0.3191		
	0.3249	0.3344		
	0.3249	0.3344		
	0.3401	0.3476		
	0.3412	0.3652		
	0.3242	0.3506		

Notes for Table 6:

1. Lumileds maintains a tester tolerance of ± 0.005 on x and y coordinates.
2. CIE 1931 x and y coordinates frame.

Table 7. Optional color bin definitions for LUXEON Altilon SMD 1x4 at MP binning conditions

CODE	x ^[1,2]	y ^[1,2]	6-DIGIT IEC CODE	TYPICAL CCT	CODE	x ^[1,2]	y ^[1,2]	6-DIGIT IEC CODE	TYPICAL CCT
2B	0.3120	0.3139	ebvG33	6460K	1B	0.3120	0.3306	fbwA23	6390K
	0.3185	0.3203				0.3169	0.3353		
	0.3192	0.3131				0.3177	0.3277		
2D	0.3131	0.3070	ebyG33	6050K	1D	0.3131	0.3232	fbyA33	6050K
	0.3185	0.3203				0.3169	0.3353		
	0.3253	0.3266				0.3246	0.3424		
	0.3256	0.3191				0.3249	0.3344		
4B	0.3192	0.3131	ecbG33	5680K	3B	0.3177	0.3277	fcbA33	5680K
	0.3253	0.3266				0.3246	0.3424		
	0.3323	0.3329				0.3325	0.3493		
	0.3323	0.3251				0.3324	0.341		
4D	0.3256	0.3191	eceG33	5350K	3D	0.3249	0.3344	fceA33	5350K
	0.3323	0.3329				0.3325	0.3493		
	0.3396	0.3392				0.3406	0.3562		
	0.3392	0.3310				0.3401	0.3476		
2A	0.3323	0.3251	ebvD33	6460K	1A	0.3324	0.341	fbwD23	6390K
	0.3109	0.3211				0.3109	0.3382		
	0.3177	0.3277				0.3161	0.3432		
	0.3185	0.3203				0.3169	0.3353		
2C	0.3120	0.3139	ebyD33	6050K	1C	0.312	0.3306	fbyD33	6050K
	0.3177	0.3277				0.3161	0.3432		
	0.3249	0.3344				0.3242	0.3506		
	0.3253	0.3266				0.3246	0.3424		
4A	0.3185	0.3203	ecbD33	5680K	3A	0.3169	0.3353	fcbD33	5680K
	0.3249	0.3344				0.3242	0.3506		
	0.3324	0.3410				0.3325	0.3579		
	0.3323	0.3329				0.3325	0.3493		
4C	0.3253	0.3266	eceD33	5350K	3C	0.3246	0.3424	fceD33	5350K
	0.3324	0.3410				0.3325	0.3579		
	0.3401	0.3476				0.3412	0.3652		
	0.3396	0.3392				0.3406	0.3562		
	0.3323	0.3329				0.3325	0.3493		

Notes for Table 7:

- LUXEON Altilon emitters are tested and binned by x and y coordinates.
- Lumileds maintains a tester tolerance of ±0.005 on x and y coordinates.

Forward Voltage Bins

Forward voltage distribution of Lumileds LEDs is very narrow, nevertheless for some applications the restriction of forward voltage is beneficial. On request individual bins are available according to table 8

Table 8. Forward voltage bin definitions for LUXEON Altilon SMD 1x4 at MP binning conditions

BIN	FORWARD VOLTAGE ⁽¹⁾ (V _f)	
	MINIMUM	MAXIMUM
X	11.60	13.40

Notes for Table 8:
 1. Lumileds maintains a tolerance of ±0.06V on forward voltage measurements.

Mechanical Dimensions

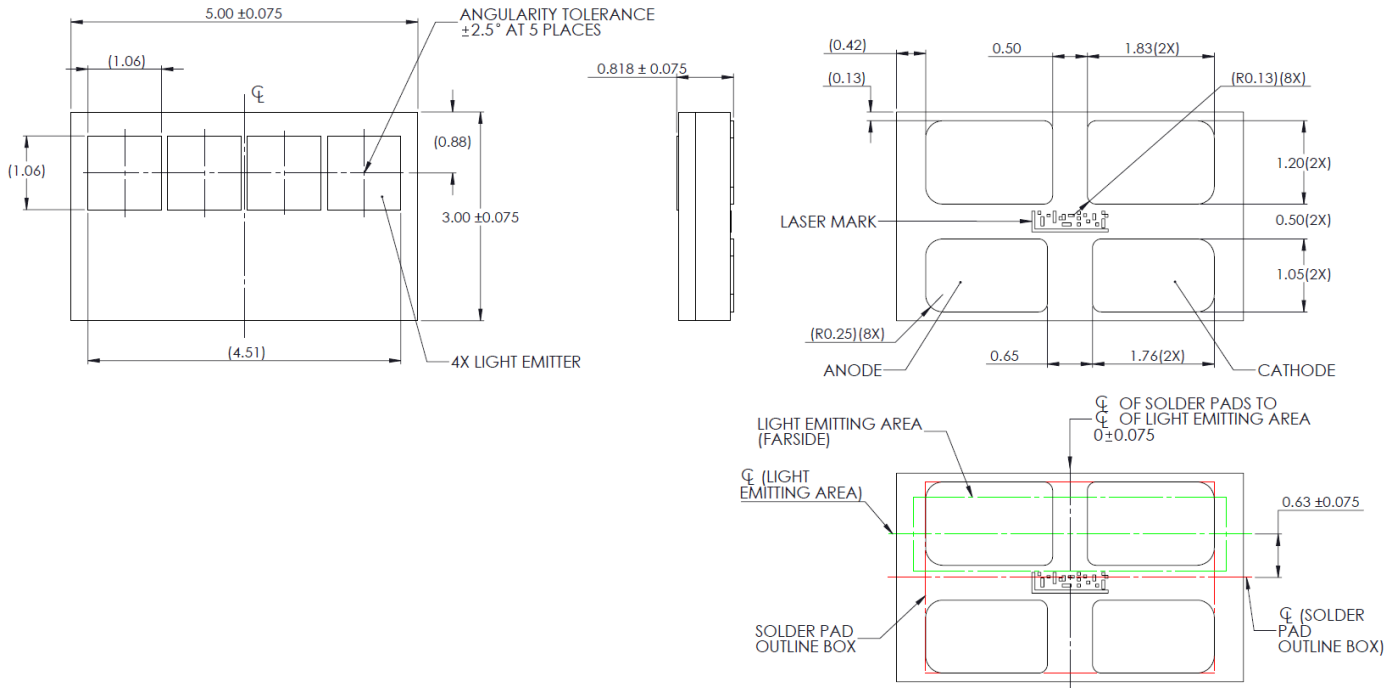

Figure 14: Mechanical Dimensions for LUXEON Altilon SMD 1x4

- Notes for Figure 14:
1. Drawings are not scale
 2. All dimensions are in millimeters

Package Weight

Table 9. Approximate weight of LUXEON Altilon SMD 1x4

PART NUMBER	PACKAGE WEIGHT [mg]
A1SC-58504DH2xxxxx	44.3

JEDEC Moisture Sensitivity

Table 10. Moisture sensitivity levels for LUXEON Altilon SMD 1x4

LEVEL	FLOOR LIFE		STANDARD SOAK REQUIREMENTS	
	TIME	CONDITIONS	TIME	CONDITIONS
1	Unlimited	≤30 °C / 85% RH	168 Hours +5 / -0	85 °C / 85% RH

Packaging Information

Pocket Tape Dimensions

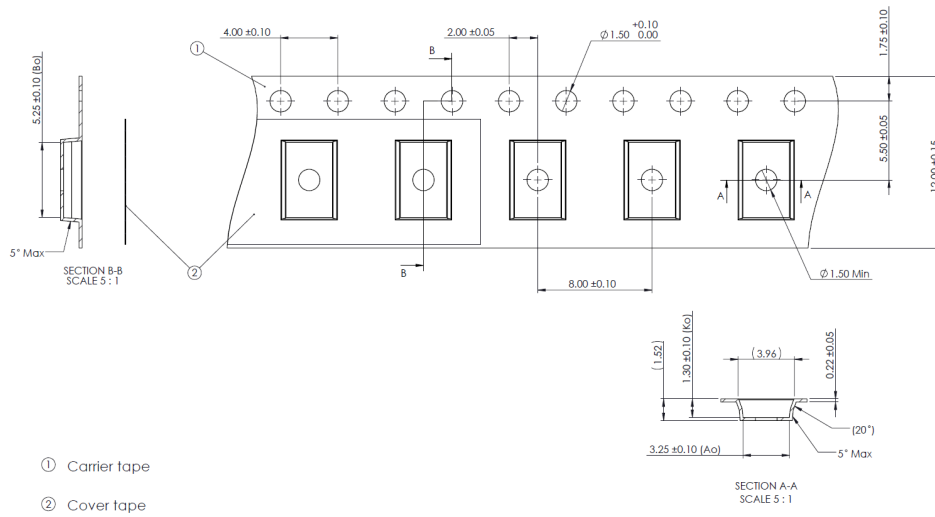

Figure 15. Pocket tape dimensions for LUXEON Altilon SMD 1x4

Notes for Figures 15:

1. Drawings are not to scale.
2. Ao is the width of pocket Ko is the depth of pocket. Bo is the height of pocket.
3. All dimensions are in millimeters.

Reel Dimensions

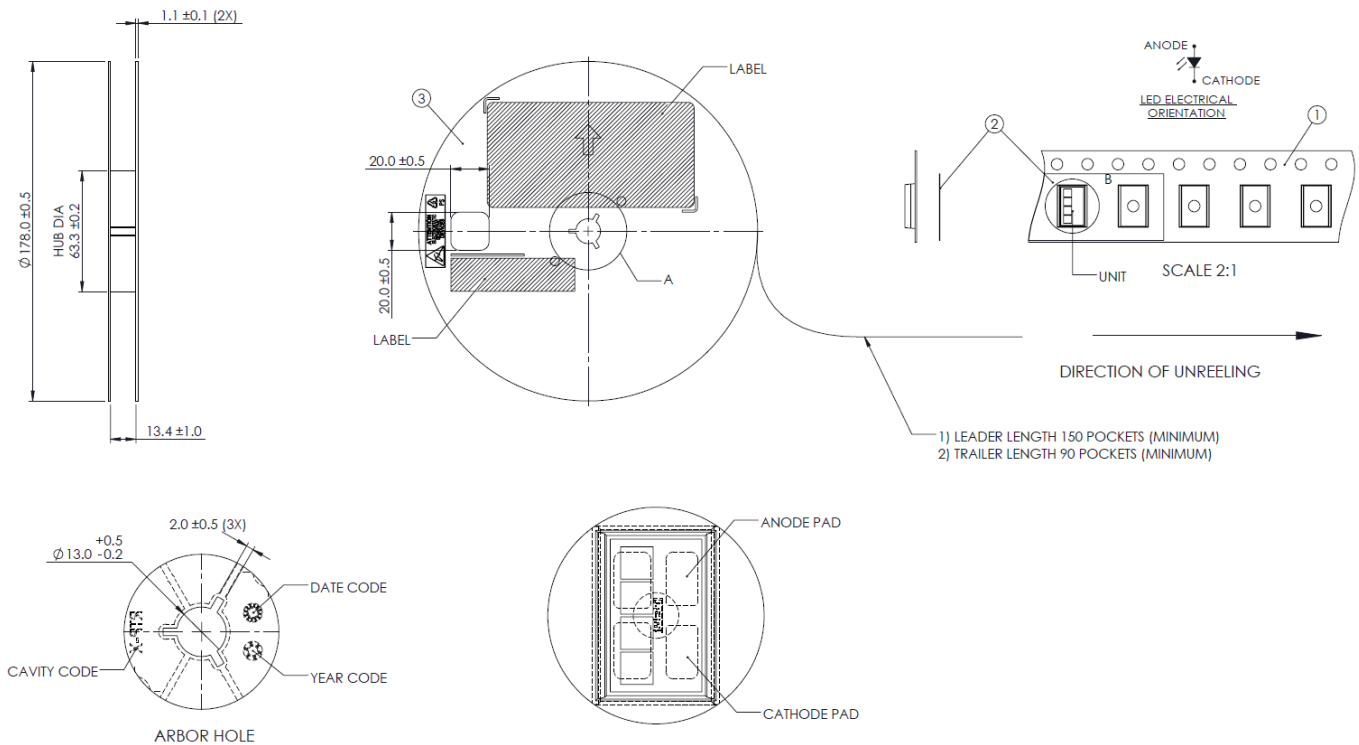

Figure 16. Reel dimensions for LUXEON Altilon SMD 1x4

Notes for Figures 16:

1. Drawings are not to scale.
2. All dimensions are in millimeters.

Product Labeling

LUXEON Altilon SMD 1x4 LEDs are packaged in moisture barrier bags on reels. Both moisture barrier bag and reels have printed information providing part numbers with CAT codes that indicate luminous flux, color and forward voltage bins.

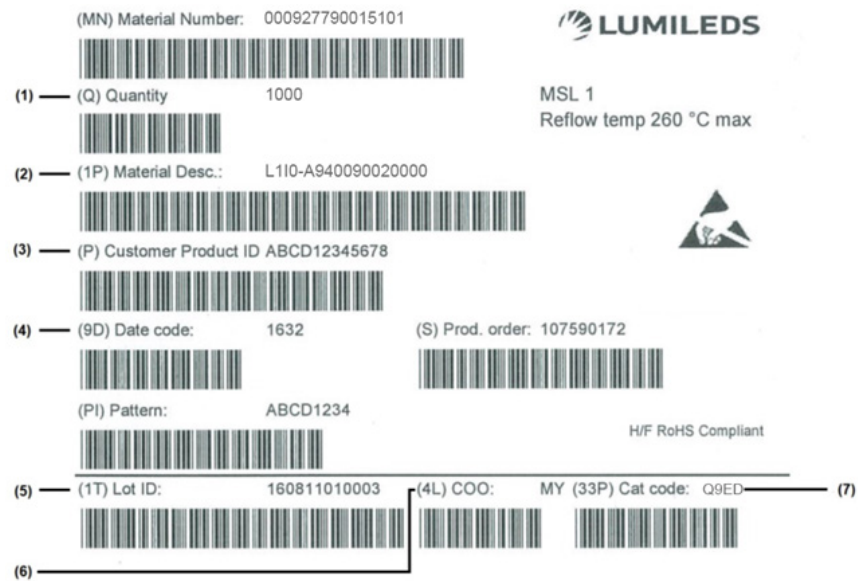

Figure 17. Example of a product label for LUXEON Altilon SMD 1x4

Notes for Figure 17 – Outer Box Label descriptions for customer use:

Field labels not described are for Lumileds internal use only.

1. (Q) Total number of LED emitters in a shipment box.
2. (1P) Lumileds part number
3. (P) Customer part number for custom requests only.
4. (9D) LED test date in YYYY format.
5. (1T) Unique product lot identification number. This number is required for traceability purposes.
6. (4L) Country code of origin of manufacturing of part (e.g. MY for Malaysia, CN for China) according to ISO 3166-1 alpha-2 document.
7. (33P) Product bin 4-digit alphanumeric CAT code.

About Lumileds

Companies developing automotive, mobile, IoT and illumination lighting applications need a partner who can collaborate with them to push the boundaries of light. With over 100 years of inventions and industry firsts, Lumileds is a global lighting solutions company that helps customers around the world deliver differentiated solutions to gain and maintain a competitive edge. As the inventor of Xenon technology, a pioneer in halogen lighting and the leader in high performance LEDs, Lumileds builds innovation, quality and reliability into its technology, products and every customer engagement. Together with its customers, Lumileds is making the world better, safer, more beautiful—with light.

To learn more about our lighting solutions, visit lumileds.com.



©2023 Lumileds Holding B.V. All rights reserved.
LUXEON is a registered trademark of the Lumileds Holding B.V. in the United States and other countries.

lumileds.com

Neither Lumileds Holding B.V. nor its affiliates shall be liable for any kind of loss of data or any other damages, direct, indirect or consequential, resulting from the use of the provided information and data. Although Lumileds Holding B.V. and/or its affiliates have attempted to provide the most accurate information and data, the materials and services information and data are provided "as is," and neither Lumileds Holding B.V. nor its affiliates warrants or guarantees the contents and correctness of the provided information and data. Lumileds Holding B.V. and its affiliates reserve the right to make changes without notice. You as user agree to this disclaimer and user agreement with the download or use of the provided materials, information and data. A listing of Lumileds product/patent coverage may be accessed at lumileds.com/patents.