

# LUXEON 2835 Color Line

## Assembly and Handling Information



### Introduction

This application brief addresses the recommended assembly and handling guidelines for LUXEON 2835 Color Line emitters. This robust color line provides high performance and is targeted at cost effective designs. Proper assembly, handling, and thermal management, as outlined in this application brief, ensure high optical output and reliability of these emitters.

### Scope

The assembly and handling guidelines in this application brief apply to the LUXEON 2835 Color Line. In the remainder of this document, the term LUXEON emitter refers to any product in the LUXEON 2835 Color Line.

# Table of Contents

Introduction .....	1
Scope .....	1
<b>1. Component .....</b>	<b>3</b>
1.1 Description .....	3
1.2 Optical Center .....	3
1.3 Handling Precautions .....	3
1.4 Cleaning .....	4
1.5 Electrical Isolation .....	4
1.6 Mechanical Files .....	4
<b>2. Printed Circuit Board (PCB) Design Guidelines .....</b>	<b>4</b>
2.1 PCB Footprint and Land Pattern .....	4
2.2 Surface Finishing .....	4
2.3 Solder Mask .....	4
2.4 Silk Screen or Ink Printing .....	5
2.5 Minimum Spacing .....	5
<b>3. Thermal Management .....</b>	<b>5</b>
<b>4. Thermal Measurement Guidelines .....</b>	<b>5</b>
<b>5. Assembly Process Guidelines .....</b>	<b>7</b>
5.1 Stencil Design .....	7
5.2 Solder Paste .....	7
5.3 Thermal Measurement Result .....	7
5.4 Pick and Place .....	7
5.5 Electrostatic Discharge Protection .....	8
<b>6. Packaging Consideration—Chemical Compatibility .....</b>	<b>9</b>
About Lumileds .....	11

# 1. Component

## 1.1 Description

The LUXEON 2835 Color Line emitter (see Figure 1) is a plastic molded, no-lead, surface mount package consisting of an anode and a cathode. A chamfer on the corner of the package marks the anode side of the emitter package. Majority of the heat is being dissipated through the larger pad (anode). For the LUXEON 2835 Color package, without the option of a transient voltage suppressor (TVS) chip to protect the emitter against electrostatic discharges (ESD), appropriate precautions should, therefore, be taken when handling such device (see Section 5.5).

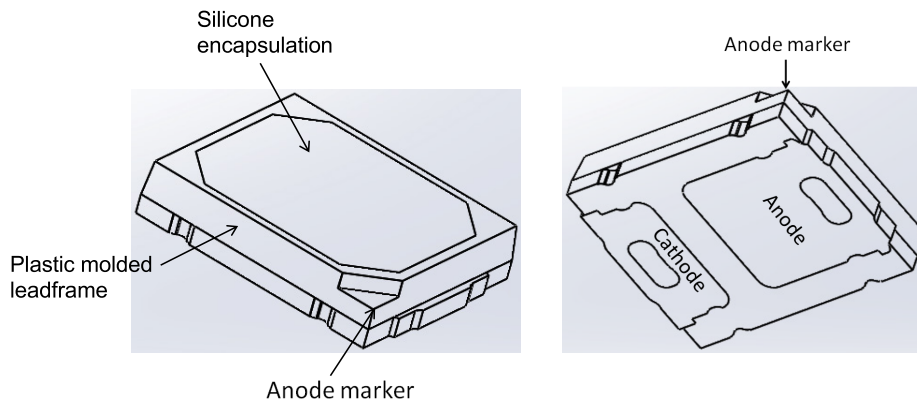

Figure 1. Package rendering of the **LUXEON 2835 Color Line**.

## 1.2 Optical Center

The optical center coincides with the mechanical center of the LUXEON emitter. Optical rayset data for the LUXEON emitter is available at [lumileds.com](http://lumileds.com).

## 1.3 Handling Precautions

The LUXEON emitter is designed to maximize light output and reliability. However, improper handling of the device may damage the silicone coating and affect the overall performance and reliability. In order to minimize the risk of damage to the silicone coating during handling, the LUXEON emitter should only be picked up from the side of the package (Figure 2).

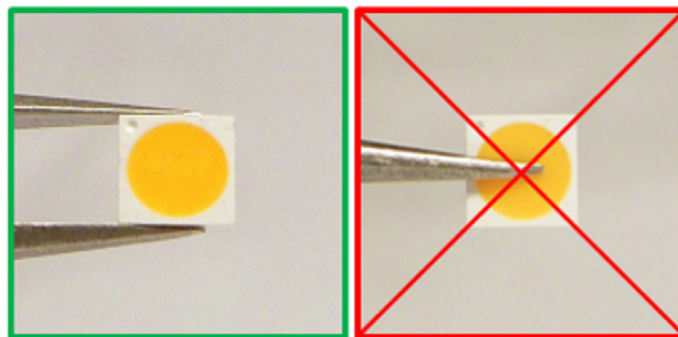

Figure 2. Illustration example of correct handling (left) and incorrect handling (right) of the LUXEON emitter.

## 1.4 Cleaning

The LUXEON emitter should not be exposed to dust and debris. Excessive dust and debris may cause a drastic decrease in optical output. In the event that a LUXEON emitter requires cleaning, first try a gentle swabbing using a lint-free swab. If needed, a lint-free swab and isopropyl alcohol (IPA) can be used to gently remove dirt from the silicone coating. Do not use other solvents as they may adversely react with the package of the LUXEON emitter. For more information regarding chemical compatibility (see Section 6).

## 1.5 Electrical Isolation

The LUXEON emitter contains two electrode pads on the package. It is important to keep sufficient distance between the LUXEON emitter package and any other objects or neighboring LUXEON emitters to prevent any accidental shorts. In order to avoid any electrical shocks, flashover, and/or damage to the LUXEON emitter, each design needs to comply with the appropriate standards of safety and isolation distances, known as clearance and creepage distances, respectively (e.g. IEC60950, clause 2.10.4).

## 1.6 Mechanical Files

Mechanical drawings for the LUXEON emitter are available on the Lumileds website at [lumileds.com](http://lumileds.com).

# 2. Printed Circuit Board (PCB) Design Guidelines

The LUXEON emitter is designed to be soldered onto a Printed Circuit Board (PCB). To ensure optimal operation, the PCB should be designed to minimize the overall thermal resistance between the LED package and the heat sink.

## 2.1 PCB Footprint and Land Pattern

The recommended PCB footprint design for the LUXEON emitter is shown in Figure 3. In order to ensure proper heat dissipation to the PCB, it is best to extend the top copper layer of the anode pad beyond the perimeter of the LUXEON emitter as much as possible (see Section 3).

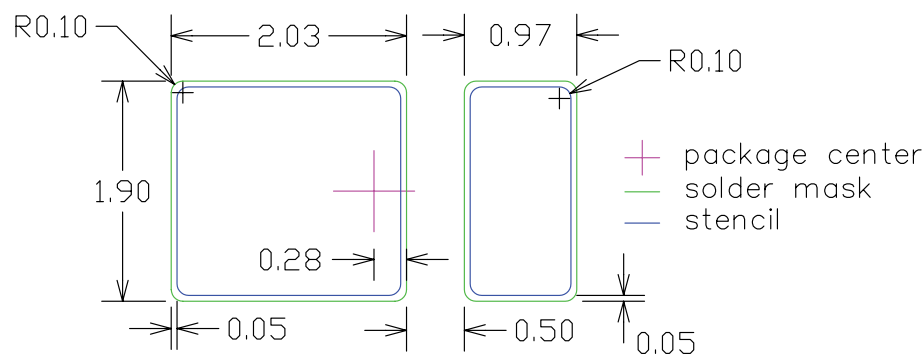

Figure 3. Recommended PCB footprint design for the **LUXEON 2835 Color Line** (dimensions are in millimeters).

## 2.2 Surface Finishing

A high temperature organic solderability preservative (OSP) or electroless nickel immersion gold (ENIG) plating on the exposed copper pads protects from oxidation.

## 2.3 Solder Mask

A white solder mask is preferred.

## 2.4 Silk Screen or Ink Printing

Ink markings within and around the LUXEON emitter outline should be avoided because the height of the ink may interfere with the self-alignment of the package during reflow.

## 2.5 Minimum Spacing

Lumileds proposes a minimum edge-to-edge spacing of 0.5mm between LUXEON emitters. Placing multiple LUXEON emitters too close to each other may adversely impact the ability of the PCB to dissipate the heat from the emitters.

# 3. Thermal Management

The overall thermal resistance between a LUXEON emitter and the heatsink is strongly affected by the design and material of the PCB on which the emitter is soldered. Metal Core PCBs, FR-4 and CEM-3 PCB substrates are commonly used to mount LEDs.

One common example of reducing the thermal resistance on PCB boards, such as MCPCB, FR-4 or CEM-3 is to maximize the copper area around the anode pad by making the cathode trace as small as possible (see Figure 4).

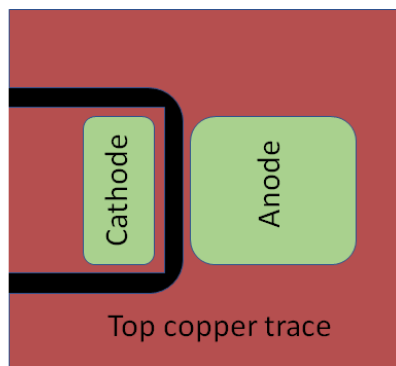

**Figure 4. The top copper trace pattern is created such as to maximize the amount of copper surrounding the anode pad. The green area represents the solder mask opening and the red area represents the top copper layer.**

Other considerations for reducing PCB thermal resistance:

- Increase top copper layer thickness (e.g. 1 oz. versus 2 oz. copper)
- On MCPCB dielectric layer, reduce the thickness and increase the thermal conductivity, in  $W/(m \cdot K)$
- On FR-4, consider open vias or filled and capped vias, but at the expense of cost and increasing complexity in meeting minimum regulatory requirement for electrical insulation, if required

# 4. Thermal Measurement Guidelines

The typical thermal resistance ( $R\theta_{j-case}$ ) between the junction and the solder pads of the LUXEON emitter is provided in the LUXEON 2835 Color Line datasheet. With this information, the junction temperature ( $T_j$ ) can be determined according to the following equation:

$$T_j = T_{case} + R\theta_{j-case} \cdot P_{electrical}$$

In this equation,  $T_{case}$  is the temperature at the bottom of the solder pads of the LUXEON emitter and  $P_{electrical}$  is the electrical power going into the emitter. In typical applications it may be difficult, though, to measure the temperature ( $T_{case}$ ) directly. Therefore, a practical way to determine the junction temperature of the LUXEON emitter is by measuring the temperature ( $T_s$ ) of a predetermined sensor pad on the PCB with a thermocouple.

The recommended location of the sensor pad is right next to the anode of the LUXEON emitter on the PCB, as shown in Figure 5. To ensure accurate reading, the thermocouple (TC) tip must make direct contact to the copper of the PCB onto which the LUXEON emitter anode pad is soldered (i.e. any solder mask or other masking layer must first be removed before mounting the thermocouple onto the PCB). The tip of the TC wire should be placed as close as possible to the LUXEON emitter package on the exposed anode copper layer (e.g. 0.5mm). The thermal resistance ( $R\theta_{j-s}$ ) between the sensor pad and the LUXEON emitter junction was experimentally determined on a 1 mm thick Al-MCPCB with the following PCB properties: 2 oz. copper and 100um thick dielectric layer with 3 W/(m·K).

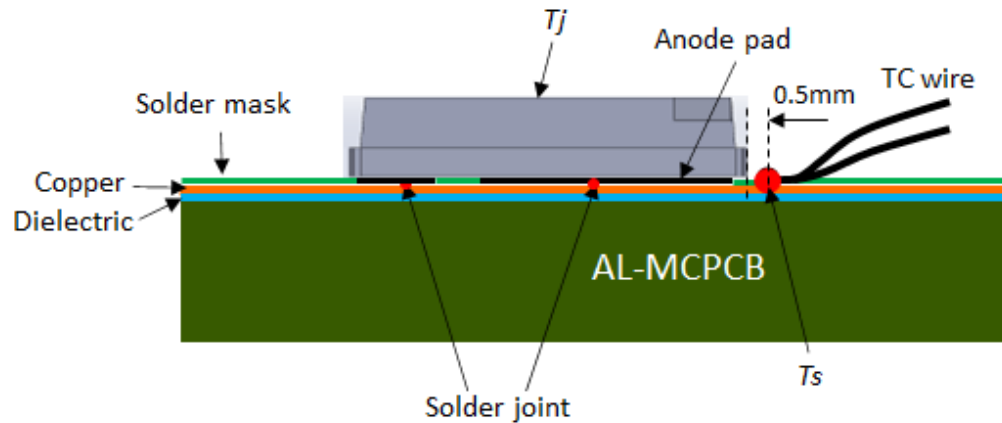

Figure 5. Cross sectional view of a two-pad LUXEON emitter on Al-MCPCB and the corresponding temperature location (top). Actual mounting of thermocouple wire closest to the **anode** pad of the **LUXEON 2835 Color** package on Al-MCPCB (bottom).

The junction temperature can then be calculated as follows:

$$T_j = T_s + R\theta_{j-s} \cdot P_{\text{electrical}}$$

It is recommended securing the tip of the TC wire to the exposed copper area with a good thermal conductive epoxy such as Artic Silver™ thermal adhesive. Note that the Artic Silver™ epoxy is not formulated to conduct electricity. During dispensing of epoxy, avoid flooding the TC wire with too much epoxy but sufficient enough to secure the TC wire for measurement. Putting more epoxy than needed may change the thermal behavior of the surrounding area.

## 5. Assembly Process Guidelines

### 5.1 Stencil Design

The recommended solder stencil thickness is 5 mils (127µm).

### 5.2 Solder Paste

Lumileds recommends lead-free solder for the LUXEON emitter such as SAC 305 solder paste from Alpha Metals (SAC305-CVP390-M20 type 3). However, since application environments vary widely, Lumileds recommends that customers perform their own solder paste evaluation in order to ensure it is suitable for the targeted application.

### 5.3 Thermal Measurement Result

The LUXEON emitter is compatible with standard surface-mount and lead-free reflow technologies. This greatly simplifies the manufacturing process by eliminating the need for adhesives and epoxies. The reflow step itself is the most critical step in the reflow soldering process and occurs when the boards move through the oven and the solder paste melts, forming the solder joints. To form good solder joints, the time and temperature profile throughout the reflow process must be well maintained.

A temperature profile consists of three primary phases:

1. Preheat: the board enters the reflow oven and is warmed up to a temperature lower than the melting point of the solder alloy.
2. Reflow: the board is heated to a peak temperature above the melting point of the solder, but below the temperature that would damage the components or the board.
3. Cool down: the board is cooled down rapidly, allowing the solder to freeze, before the board exits the oven.

As a point of reference, the melting temperature for SAC 305 is 217°C, and the minimum peak reflow temperature is 235°C.

### 5.4 Pick and Place

The LUXEON emitter is packaged and shipped in tape-and-reel which is compatible with standard automated pick-and-place equipment to ensure the best placement accuracy. Note that pick and place nozzles are customer specific and are typically machined to fit specific pick and place tools. Lumileds advises customers to take the following general pick and place guidelines into account:

- a. The nozzle tip should be clean and free of any particles since they may interact with the top surface of the silicone encapsulation of the LUXEON emitter package.
- b. During setup and the first initial production runs, it is good practice to inspect the top surface of the LUXEON emitters under a microscope to ensure that the emitters are not accidentally damaged by the pick and place nozzle.

In selecting a suitable nozzle size for picking up these LUXEON emitters, there are two important factors to consider:

1. The nozzle outer diameter or size should not be larger than the opening of the reel pocket tape otherwise it may interfere with the pocket tape cavity during the pick-up process.
2. The nozzle outer diameter or size should also not be smaller than the silicone encapsulant surface (Figure 1 and Figure 6) otherwise this may allow the nozzle tip to be in full contact with the encapsulant area and may cause damage to the surface or cause pick-up/release issues. Note that the encapsulant is typically recessed below the white plastic housing and assuming a nozzle tip that is planar, the nozzle tip is able to rest on the edge of the white plastic housing and not in full contact with the encapsulant.

See Figure 6 for the dimensions to be considered in nozzle design. There is no constraint on the nozzle inner size as long as there is sufficient vacuum to hold the LED emitter during pick and place process.

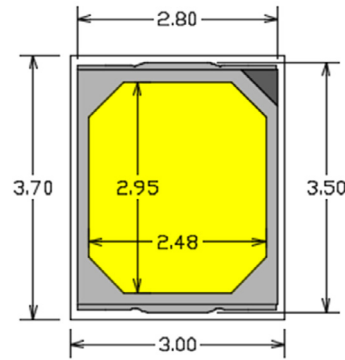

Figure 6. LUXEON 2835 Color emitter in a tape pocket with inner dimensions of 3.0mm x 3.7mm. A suitable starting point is to choose a nozzle size where the x or y dimensions or the diameter (if round nozzle) is larger than the yellow region and able to rest on the outer white plastic housing. Dimensions in mm.

An example of an off-the-shelf nozzle from Yamaha that may be suitable as a starting point to evaluate pick and place of LUXEON 2835 Color is shown in Figure 7.

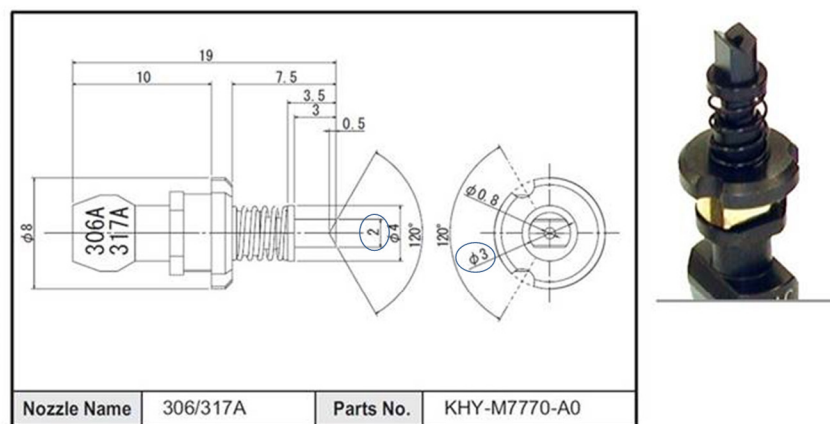

Figure 7. An example of a nozzle with outer size of 2mm x 3mm as shown on the left drawing. See the circled dimensions. Right image is the actual nozzle tip. Dimensions in mm.

## 5.5 Electrostatic Discharge Protection

The LUXEON emitter does not include a transient voltage suppressor (TVS) chip to protect against electrostatic discharges (ESD). Therefore, Lumileds recommends observing the following precautions when handling the LUXEON emitter:

- During manual handling, always wear an ESD wrist strap. Workstation surface should have an anti-static mat that is properly grounded and checked.
- All equipment, machinery, work tables, and storage racks that may get in contact with the LUXEON emitter should be properly grounded.
- Use an ion blower to neutralize the static discharge that may build up on the surface and lens of the plastic housing of the LUXEON emitter during storage and handling.

LUXEON emitters that are damaged by ESD may not light up at low currents and/or may exhibit abnormal performance characteristics such as a high reverse leakage current, and a low forward voltage (leaky diode). It is also important to take note that ESD can also cause latent failure i.e. failure or symptoms as described above may not show up immediately but only after use. Hence, continuous ESD protection is needed during assembly.



## 6. Packaging Consideration—Chemical Compatibility

The LUXEON emitter package contains a silicone overcoat to protect the LED chips and extract the maximum amount of light. As with most silicones used in LED optics, care must be taken to prevent any incompatible chemicals from directly or indirectly reacting with the silicone.

The silicone overcoat in the LUXEON emitter is gas permeable. Consequently, oxygen and volatile organic compound (VOC) gas molecules can diffuse into the silicone overcoat. VOCs may originate from adhesives, solder fluxes, conformal coating materials, potting materials and even some of the inks that are used to print the PCBs.

Some VOCs and chemicals react with silicone and produce discoloration and surface damage. Other VOCs do not chemically react with the silicone material directly but diffuse into the silicone and oxidize during the presence of heat or light. Regardless of the physical mechanism, both cases may affect the total LED light output. Since silicone permeability increases with temperature, more VOCs may diffuse into and/or evaporate out from the silicone.

Careful consideration must be given to whether LUXEON emitters are enclosed in an “air tight” environment or not. In an “air tight” environment, some VOCs that were introduced during assembly may permeate and remain in the silicone. Under heat and “blue” light, the VOCs inside the silicone coating may partially oxidize and create an appearance of silicone discoloration, particularly on the surface of the LED where the flux energy is the highest. In an air rich or “open” air environment, VOCs have a chance to leave the area (driven by the normal air flow). Transferring the devices, which were discolored in the enclosed environment back to “open” air, may allow the oxidized VOCs to diffuse out of the silicone and may restore the original optical properties of the LED.

Determining suitable threshold limits for the presence of VOCs is very difficult since these limits depend on the type of enclosure used to house the LEDs and the operating temperatures. Also, some VOCs can photo-degrade over time.

Table 1 provides a list of commonly used chemicals that should be avoided as they may react with the silicone material. Note that Lumileds does not warrant that this list is exhaustive since it is impossible to determine all chemicals that may affect LED performance.

The chemicals in Table 1 are typically not directly used in the final products that are built around the LUXEON emitter. However, some of these chemicals may be used in intermediate manufacturing steps (e.g. cleaning agents). Consequently, trace amounts of these chemicals may remain on (sub) components, such as heat sinks or on PCBs. Lumileds, therefore, recommends the following precautions when designing your application:

- When designing secondary lenses to be used over an LED, provide a sufficiently large air-pocket and allow for “ventilation” of this air away from the immediate vicinity of the LED.
- Use mechanical means of attaching lenses and circuit boards as much as possible. When using adhesives, potting compounds and coatings, carefully analyze its material composition and do thorough testing of the entire fixture under High Temperature over Life (HTOL) conditions.

**Table 1. List of commonly used chemicals that may damage the silicone overcoat of LUXEON 2835 Color.**

CHEMICAL NAME	TYPICAL USE
Hydrochloric Acid	Acid
Sulfuric Acid	Acid
Nitric Acid	Acid
Acetic Acid	Acid
Sodium Hydroxide	Alkali
Potassium Hydroxide	Alkali
Ammonia	Alkali
MEK (Methyl Ethyl Ketone)	Solvent
MIBK (Methyl Isobutyl Ketone)	Solvent
Toluene	Solvent
Xylene	Solvent
Benzene	Solvent
Gasoline	Solvent
Mineral spirits	Solvent
Dichloromethane	Solvent
Tetrachlorometane	Solvent
Castor Oil	Oil
Lard	Oil
Linseed Oil	Oil
Petroleum	Oil
Silicone Oil	Oil
Halogenated Hydrocarbons (containing F, Cl, Br elements)	Misc
Rosin Flux	Solder Flux
Acrylic Tape	Adhesive



## About Lumileds

Technology advancements in lighting, especially LED, are creating tremendous opportunities in the field of light. Lighting solutions today not only need to work and to last, they need to give customers a competitive edge. Companies developing automotive, mobile, IoT and illumination lighting applications require a partner who can collaborate with them to push the boundaries of light. With more than 100 years of inventions and industry firsts, Lumileds is a global lighting solutions company that helps customers around the world deliver differentiated solutions to gain and maintain a competitive edge.

To learn more about our lighting solutions, visit [lumileds.com](http://lumileds.com).



©2023 Lumileds Holding B.V. All rights reserved.  
LUXEON is a registered trademark of the Lumileds Holding B.V. in the United States and other countries.

[lumileds.com](http://lumileds.com)

Neither Lumileds Holding B.V. nor its affiliates shall be liable for any kind of loss of data or any other damages, direct, indirect or consequential, resulting from the use of the provided information and data. Although Lumileds Holding B.V. and/or its affiliates have attempted to provide the most accurate information and data, the materials and services information and data are provided "as is," and neither Lumileds Holding B.V. nor its affiliates warrants or guarantees the contents and correctness of the provided information and data. Lumileds Holding B.V. and its affiliates reserve the right to make changes without notice. You as user agree to this disclaimer and user agreement with the download or use of the provided materials, information and data. A listing of Lumileds product/patent coverage may be accessed at [lumileds.com/patents](http://lumileds.com/patents).