

LUXEON SunPlus 20 Line for Horticulture

Assembly and Handling Information

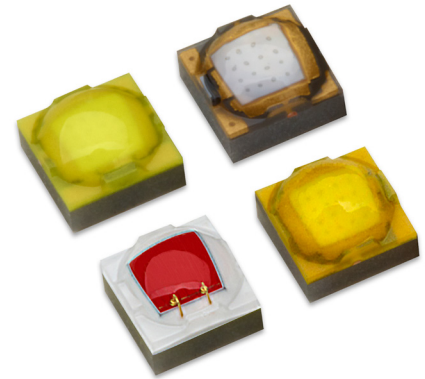

Introduction

The LUXEON SunPlus Series for Horticulture is purpose-built to enable ease of system design for Horticulture applications. The LUXEON SunPlus Series offers the only LEDs available today that are binned and tested based on Photosynthetic Photon Flux (PPF).

This application brief addresses the recommended assembly and handling guidelines for LUXEON SunPlus 20 Line for Horticulture. Proper assembly and handling, as outlined in this application brief, ensures high optical output and the long-term performance of LUXEON emitter.

Scope

The assembly and handling guidelines in this application brief apply to the all following LUXEON products:

PRODUCT NAME	PART NUMBER
LUXEON SunPlus 20 Far Red	L1SP-FRD0002000000
LUXEON SunPlus 20 Deep Red	L1SP-DRD0002000000
LUXEON SunPlus 20 Royal Blue	L1SP-RYL0002000000
LUXEON SunPlus 20 Lime	L1SP-LME0002000000
LUXEON SunPlus 20 Cool White	L1SP-CW90002000000

In the remainder of this document the term LUXEON emitter refers to any product in the LUXEON SunPlus 20 Line listed above.

Table of Contents

Introduction	1
Scope	1
1. Component	3
1.1 Description	3
1.2 Optical Center	3
1.3 Handling Precautions	4
1.4 Cleaning	4
1.5 Electrical Isolation	4
2. Optical Design Consideration	5
3. LUXEON SunPlus 20 Printed Circuit Board Design.	5
3.1 Thermal and Optical Considerations	5
3.2 LUXEON SunPlus 20 Footprint and Land Pattern	5
3.3 Surface Finishing	6
3.4 Solder Mask	6
3.5 Silkscreen (Ink) Printing	6
3.6 PCB Substrate Selection and Design Consideration	6
3.7 PCB Quality and Supplier	8
4. LUXEON SunPlus 20 Electrical Layout Consideration	8
5. Assembly Process Guidelines	10
5.1 Solder Paste	10
5.2 Stencil and Stencil Printing	11
5.3 Pick and Place	12
5.4 Reflow	16
5.5 Component Spacing	17
5.6 Board Handling and Bending	17
5.7 Rework	17
6. Thermal Measurement Guidelines.	17
6.1 Thermal Basics.	17
6.2 Temperature Sensor Pad (Ts) and Thermocouple (TC) Attachment	18
6.3 Thermal Measurement Result.	18
7. Packaging Considerations—Chemical Compatibility.	19
About Lumileds	21

1. Component

1.1 Description

The LUXEON SunPlus 20 emitter consists of either an InGaN (indium gallium nitride) or an AlInGaP (aluminum indium gallium phosphide) LED chip mounted onto a ceramic substrate which is encapsulated in silicone (Figure 1) to protect the underlying chip, wire bonds (in AlInGaP) and the phosphor layer (in white and PC Amber). The ceramic substrate provides mechanical support and thermally connects the LED chip to the bottom pads. The solder pads on the bottom of LUXEON SunPlus 20 are finished with gold. A transient voltage suppressor (TVS) chip is added to all LUXEON SunPlus 20 products with InGaN LED chips to protect against ESD events; LUXEON SunPlus 20 products with AlInGaP LED chips do not have one.

The bottom of LUXEON SunPlus 20 contains three metallization pads, a large thermal pad in the center and an anode and a cathode. The cathode pad can be easily identified by referencing to the cathode reference marker (Figure 1).

LUXEON SunPlus 20 is designed to be compatible with standard surface mount technology (SMT) process.

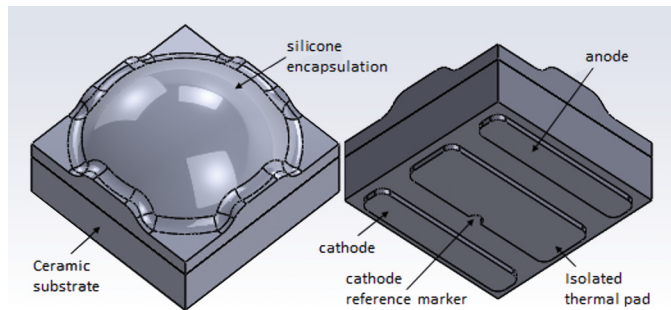

Figure 1: Image rendering of LUXEON SunPlus 20 emitter.

1.2 Optical Center

The theoretical optical center of LUXEON SunPlus 20 (top view) coincides with the mechanical center of the package (Figure 2). The actual optical center defined as the relative position of dome centering to the LED chip centering is within a circular diameter of 0.10mm with respect to the theoretical optical center.

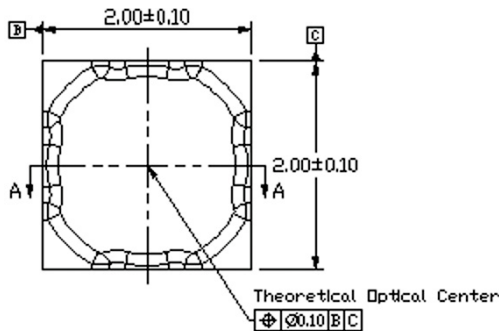

Figure 2: Optical center. All dimensions in mm.

Optical rayset data for the LUXEON emitter is available on the Lumileds website at lumileds.com.

1.3 Handling Precautions

LUXEON SunPlus 20 emitters are designed to maximize light output and reliability. However, improper handling may damage the silicone dome of the emitter and affect its overall performance and reliability. In order to minimize the risk of damage to the silicone dome during handling, LUXEON SunPlus 20 emitters should only be picked up from the side of the ceramic frame as shown in Figure 3.

Assembled boards must not be stacked up on top of each other or placed upside down on any surface to avoid damaging the dome.

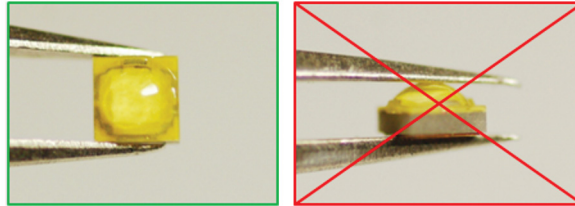

Figure 3: Correct handling (left) and incorrect handling (right) of LUXEON SunPlus 20.

1.4 Cleaning

Any fine dust and debris on and around the package may cause a decrease in light output. Use a clean air blower (e.g. at 10psi) at a distance of about 6 inches from the emitter to remove any dust and/or debris after the emitter is reflowed onto a PCB. Make sure the PCB is secured first.

In the event that a LUXEON emitter requires additional cleaning, try a gentle swabbing using a lint-free swab. If needed, a lint-free swab and isopropyl alcohol (IPA) can be used to gently remove stubborn dirt from the lens. Be careful that the dirt to be removed will not scratch the dome. Do not use any other solvents as they may adversely react with the LED assembly. For more information regarding chemical compatibility, see section 6.

It is safe to clean LUXEON SunPlus 20 emitters with de-ionized DI water. Using municipal or city water may introduce other contaminants that may adversely react with the LED assembly.

1.5 Electrical Isolation

The thermal pad of the LUXEON emitter is electrically isolated from its cathode and anode. Consequently, a high voltage difference between electrical and thermal metallization may occur in applications where multiple emitters are connected in series. In such application design, the isolated thermal pad of the LUXEON emitter can be connected to the anode or cathode to minimize the possibility of electrical discharge across the anode/cathode to the thermal pad, for example when subjected to electrical isolation test (“hi-pot test”). As a reference, the nominal distance between the anode/cathode and the thermal pads of the LUXEON emitter is 0.30mm.

In order to avoid any electrical shocks and/or damage to the LUXEON emitter, each design needs to comply with the appropriate standards of safety and isolation distances, known as clearance and creepage distances, respectively (e.g. IEC 60950-1 ed.2.2, clause 2.10.4).

For more information about circuit board design to protect LED emitters during electrical overstress, please see Lumileds document AB06 “Circuit Design and Layout Practices to Minimize Electrical Stress.”

2. Optical Design Consideration

To ensure optimum plant growth and power efficiency with artificial lights, there are two important optical design considerations:

- a. Uniform light and color (spectral) distribution. To avoid negative effects from phototropism, a high level of light uniformity is required. The main plant stem will grow towards the light source (minimize “hot spots”). The lower section of the plant leaves may be shadowed by the upper section thus reducing photosynthesis. Choosing the right LEDs, light source placement and/or using secondary optics (e.g. reflectors or lenses) can help to achieve the desired objective.
While not yet proven, some studies have shown that the blue light promotes vegetative growth while the red light aids in fruiting and flowering, so a good mixing of such colors is sometimes essential.
- b. Maintain optimum PPFD (photosynthetic photon flux density in $\mu\text{mol/s/m}^2$) level. PPFD follows inverse square law, i.e. it will change to the square distance from the plant. For area being illuminated, it follows the square law. Note that beyond certain optimum PPFD level, the rate of photosynthesis tapers off with increasing PPFD, thus reducing the rate of return on power consumption versus plant growth rate. The optimum PPFD level varies with each plant type.

Please visit the [Lumileds](#) website for downloading optical rayset files, IES file format (per LM-63-02) and using Lumileds Design Tools for optical design and simulations.

3. LUXEON SunPlus 20 Printed Circuit Board Design

LUXEON SunPlus 20 is engineered to be surface mounted onto a ceramic, metal-core PCB (MCPCB) or FR-4/CEM-3 substrate.

3.1 Thermal and Optical Considerations

LUXEON SunPlus 20 has three pads that need to be soldered onto corresponding pads on the PCB. There are two important aspects to consider when designing a PCB for a LUXEON emitter: thermal and optical performance.

To achieve optimum thermal performance, choose the appropriate PCB substrate and design (see Table 1) for the required relative performance and cost consideration.

To maximize light output performance, it is important to use a white reflective solder mask.

3.2 LUXEON SunPlus 20 Footprint and Land Pattern

Figure 4 shows the recommended PCB footprint and stencil pattern for LUXEON SunPlus 20. For a long and narrow anode/cathode pad, solder mask defined pad design should be considered. The L-shaped package outline fiducials are optional to facilitate manual placement and package alignment inspection.

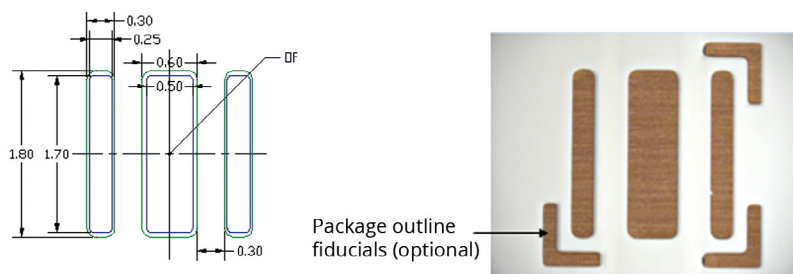

Figure 4: LUXEON SunPlus 20 PCB footprint (top). Actual LUXEON SunPlus 20 PCB with white solder mask and optional package outline fiducials (bottom). All dimensions in mm.

3.3 Surface Finishing

Lumileds recommends using electroless nickel immersion gold (ENIG) or high temperature organic solderability preservative (OSP) on the exposed copper pads of the PCB to protect the pads from oxidation prior to reflow. Hot air solder leveling (HASL) should not be used because it yields poor co-planarity (leveling) and is, therefore, not suitable for assembly of small pad devices such as LUXEON SunPlus 20.

3.4 Solder Mask

A stable white solder mask finish (typically a polymer compound with inert reflective filler) with high reflectivity in the visible spectrum will typically meet most application needs. The white finish should not discolor over time. Customers are encouraged to work with their PCB suppliers to determine the most suitable solder mask options which can meet their application needs. It is important to note that the thickness of the solder mask will have an impact the overall solder paste thickness.

Lumileds has positive testing result of the performance of Taiyo PSR-4000 LEW3 solder mask.

3.5 Silkscreen (Ink) Printing

Ink markings within and around the LUXEON emitter outline should be avoided because the height of the ink may impact the alignment accuracy of the solder stencil (solder paste) printing process and/or may interfere with the ability of the LUXEON emitter to self-align during reflow. If needed, the ink printing should be at least 1 mm away from the LUXEON emitter outline.

3.6 PCB Substrate Selection and Design Consideration

Table 1: provides a summary of various relevant performance characteristics of common PCB substrates to aid material selection.

	FR-4/CEM-3	MCPCB	CERAMIC PCB
Cost	Low to medium	Medium	High
PCB thermal conductivity performance	Very low to medium (for filled and capped via)	Medium to excellent	High to excellent
Coefficient of thermal expansion (CTE)	Good CTE matching to LUXEON emitter	Moderate CTE matching to LUXEON emitter	Good CTE matching to LUXEON emitter
LED assembly packing density (thermal resistance consideration)	Suitable for low density applications with a large spacing between LEDs and/or low operating current	Suitable for medium density applications with a moderate spacing between LEDs	Suitable for high density applications with a minimal spacing between LEDs.
Mechanical assembly and handling	Easy as board does not easily break	Easy as board does not easily break	Extra precaution to prevent ceramic breakage (hard and brittle)
Supplier availability	High	High	Limited

Specific PCB design considerations for each substrate material are summarized below.

Metal Core PCB

The most common MCPCB construction consists of the following layers (Figure 5):

- A metal substrate, typically aluminum. In some applications, a copper substrate may be more appropriate due to its higher thermal conductivity than aluminum (401 Wm⁻¹K⁻¹ versus 237 Wm⁻¹K⁻¹) but more expensive.
- Epoxy dielectric layer. This is the most important layer in the MCPCB construction as it affects the thermal performance, electrical breakdown strength, and, in some cases, the solder joint performance of the MCPCB system. The typical thermal conductivity of the dielectric layer on a MCPCB is around 2Wm⁻¹K⁻¹. A higher value is better for good thermal performance. A thinner dielectric layer is better for thermal performance as well but can negatively impact the ability of the MCPCB to withstand a Hi-Pot (high potential) test to meet minimum electrical safety standards as required in certain lighting markets. The typical dielectric thickness layer is about 100µm. In critical applications,

which need to meet strict solder joint reliability requirements, it is desirable to work with PCB manufacturers to design and engineer a low stress dielectric layer. The low stress dielectric layer can then absorb the stress generated when there is a moderate CTE mismatch between LUXEON emitter and the PCB substrate.

- Top copper layer. A thicker copper layer improves heat spreading into the PCB but may pose challenges for PCB manufacturers when fabricating narrow traces or spaces. A copper thickness of 1oz (35µm) or 2oz (70µm) is common. For optimum thermal performance on 1oz and 2oz copper designs, the copper area should extend at least 3mm from the package outline.

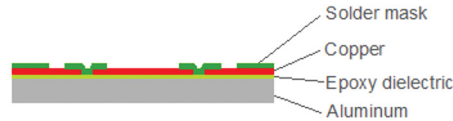

Figure 5: MCPCB typical cross section of the three-pad openings with aluminum substrate.

FR-4/CEM-3 PCB

FR-4/CEM-3 board construction consists of the following layers (Figure 7):

- FR-4 (woven fiber glass fabrics reinforced epoxy laminate, Figure 7) sheet or CEM-3 (composite epoxy material constructed from both woven and non-woven fiber glass fabrics). These two materials have excellent electrical insulation properties but have very poor thermal conductivity. Both are priced economically and are widely available. For detail specifications on PCBs, it is best to refer to a standard generated by Association Connecting Electronics Industries, (ipc.org), IPC-4101C “Specification for Base Materials for Rigid and Multilayer Printed Boards” standard.
- Top and bottom copper layers. To improve thermal performance, add thermal vias around the electrically isolated thermal pad when using plated-through-hole design (Figure 6) or within the thermal pad when using filled and capped via design. It is not desirable to put thermal vias on copper trace which connect to the electrodes of the emitters as this may interfere with the electrical insulation strength of the PCB and the heat sink. The filled and capped approach gives better thermal performance than open via design but at a much higher manufacturing cost. In addition it requires good surface co-planarity when assembling small packages. The diameter of the vias, their position, and quantity need to be studied to find the optimum thermal performance at acceptable cost. For simple designs without thermal vias, having large area and thicker (e.g. 2oz) top copper layer around the LUXEON emitter can improve the thermal performance when compare to smaller area and thin (e.g. 1oz) top copper layer. The bottom copper layer does not aid the thermal flow.

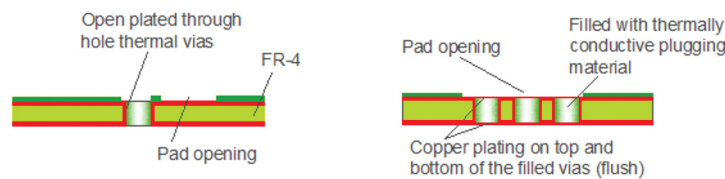

Figure 6: Left picture shows a cross section of an open via with plated through hole design with one pad opening where the LED pad is soldered onto. Right picture shows a cross section of a filled and cap via design with one pad opening. One of the LED pads is then soldered on top of the flush area where the filled and capped vias are underneath it to create direct thermal path connection between LED and bottom of PCB.

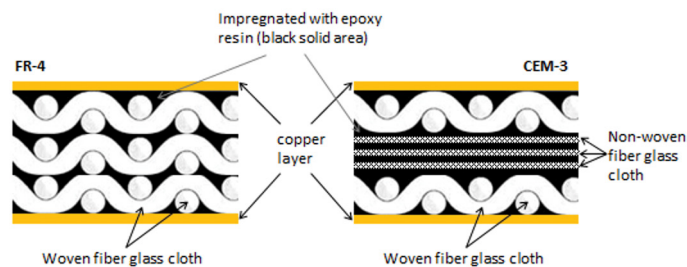

Figure 7: Cross section of a FR-4 and CEM-3 PCBs. Not drawn to scale; for illustration purposes only.

Ceramic PCB

Ceramic PCB construction consists of the following layers (Figure 8):

- Ceramic substrate. Commonly used materials are alumina (Al₂O₃) or aluminum nitride (AlN). The thermal conductivity of alumina ranges from 20 to 30 Wm⁻¹K⁻¹, depending on the grades of alumina material in the substrate. The thermal conductivity of aluminum nitride ranges from 170 to 230 Wm⁻¹K⁻¹.
- Top copper layer.
- Solder mask.

Ceramic has an excellent thermal conductivity and is a very good electrical insulator. Therefore, there is no need to include any epoxy dielectric layer, allowing LUXEON emitter to be directly attached to the ceramic via copper and solder material. This enables very tight packing of multiple LUXEON emitters and operation of LUXEON emitters at much higher current.

However ceramic can be brittle and may require extra handling precautions during assembly and handling.

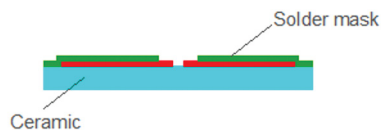

Figure 8: Cross section of ceramic based PCB. Note that there is no dielectric epoxy layer between copper (red) layer and the ceramic substrate which make ceramic PCB an excellent solution for high current operation with high density packing.

3.7 PCB Quality and Supplier

It is important to select PCB suppliers that are capable of delivering the required level of quality. At a minimum, the PCBs must comply with IPC standard (IPC-A-600H, 2010 "Acceptability of Printed Boards"). The choice of PCB classification (Class 1, 2 or 3) as per IPC standard largely depends on the intended end product and/or customer requirement. Things to watch for include:

- PCB bowing and twisting
- Significant solder mask mis-registration
- Cracks in the solder mask layer which may result in undesirable exposure of the copper layer underneath
- Contaminated copper pad openings
- Out of tolerance pad openings

It is recommended to work out with individual PCB manufacturers on the PCB tolerances that will ensure high PCB assembly yield and quality.

4. LUXEON SunPlus 20 Electrical Layout Consideration

LED failures can behave either as an electrical open circuit (e.g. a wire bond inside the package is broken or cracked solder joint) or an electrical short (e.g. an insulator layer between anode and cathode within the LED chip has broken down).

Further, multiple LEDs can be electrically connected in three major configurations as shown in Figure 9.

- a. Series. All LEDs are electrically connected in single string.
- b. Series-parallel. LED strings are electrically connected in parallel. Each LED string may consist of a single LED or multiple LEDs. The total forward voltage of each LED string must closely match for optimal performance. This can be achieved, for example, by using LEDs from the same forward voltage bin and by operating the LEDs at the datasheet test current.
- c. Series-parallel cross-connected. Each LED is connected as an array as shown in Figure 9. The forward voltage of individual LED in parallel to other LEDs must closely match, unlike in series-parallel where only the LED string voltage must match instead of individual LED.

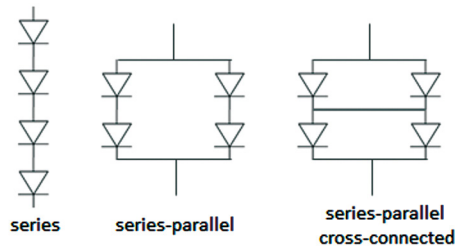

Figure 9: An example of how four LEDs can be connected.

How the LEDs are electrically connected and the types of LED failures may affect the overall LED system reliability and its performance. Table 2 describes the problem seen for various electrical configurations due to possible failure modes on a LED. Having multiple or multiple-channel constant current sources to operate each LED string rather than connecting LEDs in series-parallel configuration offers the best solution but needs to weigh in on the cost factor. Operating a high-power LED with a constant voltage source is not recommended.

Table 2: Effect of LED failure in three different electrical configurations on system reliability and performance when operating with a single constant current source.

ELECTRICAL CONFIGURATION OF LED SYSTEM	LED WITH AN OPEN FAILURE	LED WITH A SHORT FAILURE
Series	The LED system will not light up.	The LED system will still light up but the voltage drop may impact the ability of the power supply to maintain the same current output. The light output of the LED system will be proportionally reduced based on the number of LED failures.
Series-parallel	All the current will be diverted to the remaining good LED strings. Forward voltage will increase since more current will be diverted into each LED string and may cause current and thermal run-away. In this configuration, having fewer LEDs in a string but more parallel strings may help to mitigate the effect of an open failure. The average current through each remaining string is easy to determine.	The LED string with short failure will experience more current flowing through it and can cause current and thermal run-away. In this configuration, LED with high series resistance and/or adding more LEDs or even resistor (reduce system efficacy) in each string may possibly mitigate the effect of short failure. The average current through each remaining string is not easy to determine.
Series-parallel cross-connected	All the LEDs that are in parallel to the failed LED will see increase in current flowing through them. For large arrays, a single failed LED may not have a noticeable impact on the overall LED system performance	All the LEDs that are in parallel to the failed LED will not light up. When compare to the open failure system, the overall LED system performance will be impacted more.

A case example: Consider a LED system connected in series-parallel where each LED string has n LEDs in series and there are two parallel LED strings driven by one constant current power supply (Figure 10). In this example, the current flowing through each string (I_{f1} and I_{f2}) is about equal since the two LED strings have good forward voltage matching (by design).

- a. An open failure on one LED unit (LED₂₂ in Figure 10) results in all of the current ($I_{f1} + I_{f2}$) flowing through LED string #1. The forward voltage of the LED will increase from V_{AB} to V_{ABo} (Figure 10 graph). The increase in both the current and voltage may potentially exceed the thermal design of the LED system or the LED max rating which may cause the LED string #1 to fail eventually.
- b. Short failure on one LED unit (LED₂₂) in LED string #2 will result in the current-voltage curve to shift to the left as shown in the red arrow of Figure 10 graph. The forward voltage across both LED strings will drop from V_{AB} to V_{ABs} until the total current remains the same as the output of the constant current source i.e. $I_{f1} + I_{f2} = I_{f1s} + I_{f2s}$ where $I_{f2s} > I_{f1s}$. If thermal equilibrium is not achieved immediately in LED string #2, the excessive heating due to increase current flow will continue to shift its current-voltage curve further to the left as shown Figure 11. Eventually the entire LEDs in that string will fail due to cascading failures.

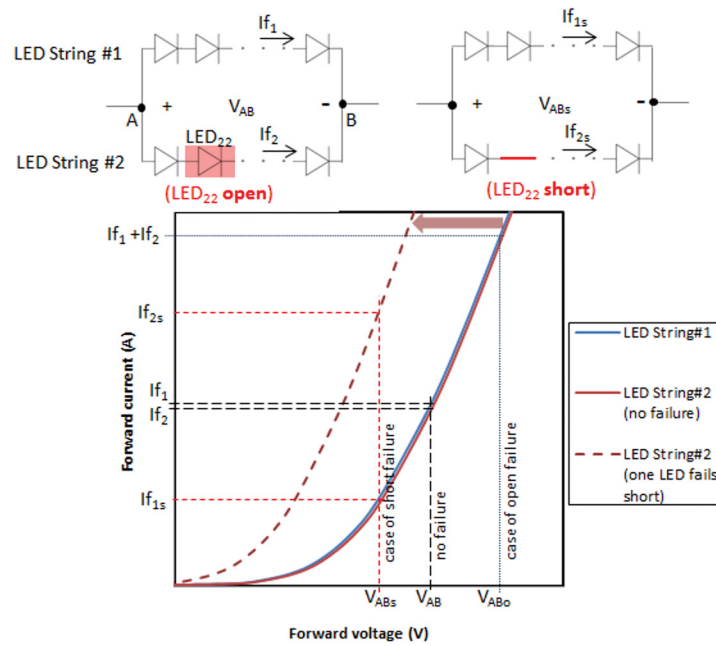

Figure 10: Case example of a series-parallel configuration showing how the current-voltage curve shift when one LED fails short.

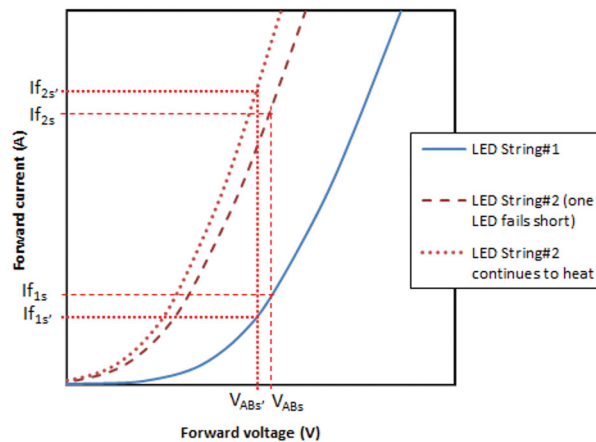

Figure 11: Thermal run-away on LED string #2 due to increase current (therefore heating) will further shift its current-voltage curve to the left and increase the LED string#2 current from I_{f_2s} to $I_{f_2s'}$.

5. Assembly Process Guidelines

LUXEON SunPlus 20 is designed to be compatible with standard SMT processes. A SMT process typically consists of SMT components, PCBs, stencil plate, solder paste, pick and place machine, solder heat reflow oven and optional x-ray and cleaning equipment.

5.1 Solder Paste

Lumileds successfully mounted LUXEON SunPlus 20 on PCBs with Alpha OM338 (type 3) and Henkel Loctite LF700 96SC DAP 88.5 DK (type 4) solder pastes. Given the large variety of solder pastes in the market, customers should always perform their own solder paste evaluation in order to determine if a solder paste will meet the customer's assembly and application requirements.

5.2 Stencil and Stencil Printing

Stencil apertures are commonly created using either electroforming or laser-cutting. The recommended stencil thickness for LUXEON SunPlus 20 is 5mils (127 μ m). It may be necessary to make some adjustments to the stencil thickness (for examples with the use of thicker solder mask) and aperture openings to optimize the quality of the solder joint under customer's own assembly process. In some cases, applying nano-coating material to the stencil aperture can improve the paste transfer efficiency (shape and volume) and reduce solder bridging. There are also several other important factors for consideration in obtaining good quality stencil printing (Figure 12). They are:

1. The aperture (stencil opening) wall should be smooth, free of debris, dirt, and/or burrs, and have a uniform thickness throughout the stencil plate.
2. Positional tolerance between the stencil plate and the PCB substrate must be small enough to ensure that the solder paste is not printed outside the footprint area. Hence both the stencil plate and the PCB must be secured properly during screen printing of the solder paste.
3. During solder paste dispense, the stencil plate must be flush with the top of the solder mask. Large particles between the stencil plate and PCB may prevent a good contact.
4. The PCB substrate must be mechanically supported from the bottom to prevent flexing of the PCB during solder paste dispenses.

Using an automatic stencil printing machine with proper fiducials or guiding feature on the PCB and the stencil plate will yield the best accuracy and repeatability for the solder paste deposition process. A manual stencil printing process is not recommended for the small pad features.

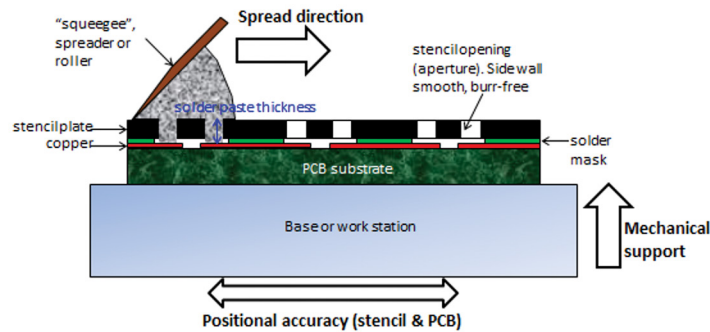

Figure 12: Stencil printing process.

Figure 13 shows some examples of a good and bad solder paste dispense process for a two and three pads LED emitters. A good reference to acceptable solder paste printing criteria can be found in IPC-7527 "Requirements for Solder Paste Printing" document. A good solder paste printing is achieved when the size of the solder paste on the PCB after dispense matches the size of the stencil opening and is centered to the PCB land pattern. Stencil printing direction should follow the long side of the pads to increase the success that the stencil opening is being completely filled with solder paste (Figure 14).

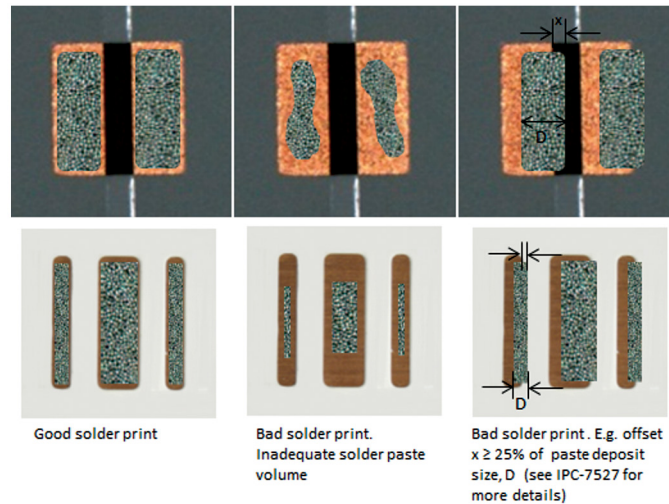

Figure 13: Examples of good and bad solder print on a two and three pads emitter. Visual inspection of the quality of the dispensed solder paste is recommended during process setup or during trouble shooting.

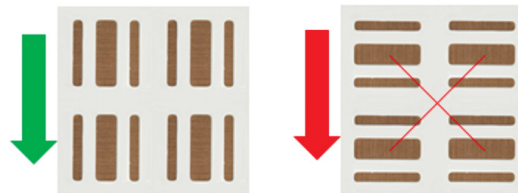

Figure 14: When possible, the PCB should be oriented such that the stencil printing direction is along the long side of the pads (green arrow, left picture). Avoid the stencil printing direction perpendicular to the long side of the pads (red arrow, right picture).

5.3 Pick and Place

Automated pick and place equipment provides the best placement accuracy for LUXEON emitters. However, pick and place nozzles are, in general, customer specific and are typically machined to fit specific pick and place tools. Below is a general pick and place guidelines when handling LUXEON emitter:

- The nozzle tip should be clean and free of any particles since this may interact with the silicone surface of LUXEON emitter during pick and place.
- During setup and the first initial production runs, it is a good practice to inspect the top surface or the dome of LUXEON emitter under a microscope to ensure that emitters are not accidentally damaged by the pick and place nozzle.
- Observe for emitters sticking to the nozzle or emitters coming out from the pocket tape during the initial run.
- Check that the emitter orientation is correctly placed onto the PCB board.

Nozzle design

The optimal way to pick up LUXEON SunPlus 20 is from the dome. Care should be taken not to damage the dome during pick and place. As a reference the dome of LUXEON SunPlus 20 has a radius of 1.12mm and the typical A Shore hardness of the dome is 86 (Figure 15). In general, materials such as polyurethane (PU) and polyether ether ketone (PEEK) with A Shore hardness close to the LUXEON SunPlus 20 dome hardness will be a good starting choice of material for a pick and place nozzle. Anti-stick coating (optional) can be applied if units (sporadically) stick to the nozzle.

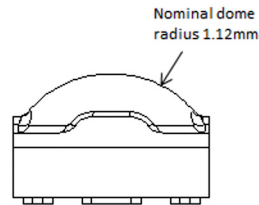

Figure 15: LUXEON SunPlus 20 nominal dome radius.

Figures 16 and 17 show the pick and place nozzles (without anti-stick coating), which were successfully used by Lumileds to place LUXEON SunPlus 20 units onto a PCB on Assembleon AX-3, Yamaha MG-8 and MyData MY-12 pick and place machines. Since assembly environments may vary, customers should do their own evaluation to verify that a particular nozzle design can meet the desired assembly yield, quality and output rate.

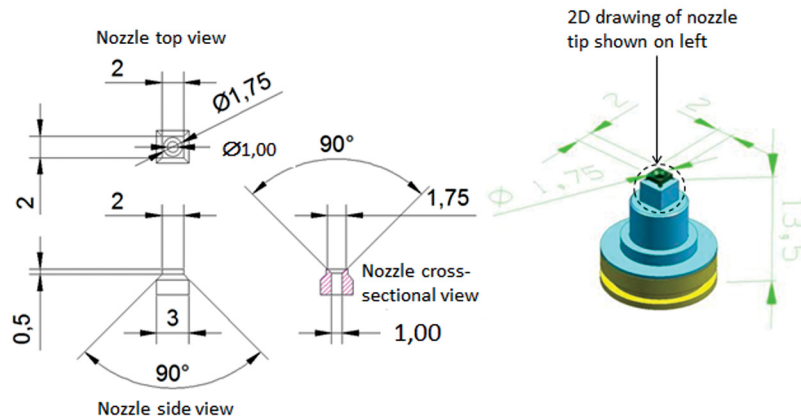

Figure 16: An example of nozzle design evaluated on Assembleon AX-3 and Yamaha MG-8 pick and place machines. Dimensions in mm.

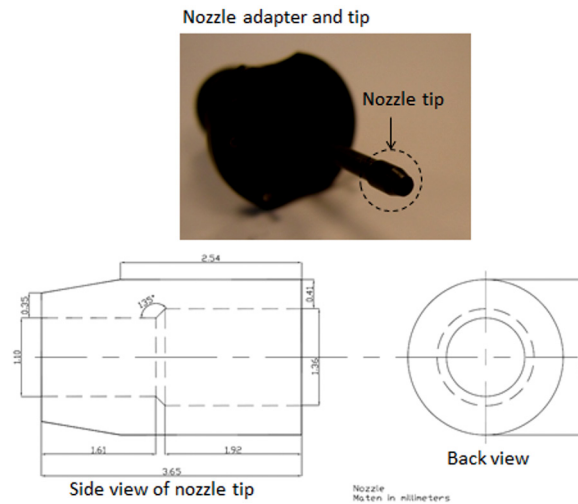

Figure 17: An example of nozzle design evaluated on MyData MY-12 pick and place machine. This is a standard A13 nozzle type for MyData. Dimensions are in mm.

Feeder system

Pick and place machines are typically equipped with special pneumatic or electric feeders to advance the tape containing the LEDs. In pneumatic feeders, air pressure is used to actuate an air cylinder which then turns the sprocket wheel to

index the pocket tape; electric feeders, in contrast, use electric motors to turn the sprocket wheel (see Figure 18). Electric feeders often also contain a panel which allows an operator to control the electric feeder manually.

The indexing step in the pick and place process may cause some LEDs to accidentally jump out of the pocket tape or may cause some LEDs to get misaligned inside the pocket tape, resulting in pick-up errors. Depending on the feeder design, minor modifications to the feeder can substantially improve the overall pick and place performance of the machine and reduce/eliminate the likelihood of scratch or damage to the LEDs.

There are many types of pick and place feeder designs available. Some feeders can be used as-is without any further modifications, some feeders require a shift in the position where the cover tape is peeled off the tape, and yet other feeders require the shutter to be completely removed so that the cover tape peeling position can be adjusted. Figure 19 shows representative pictures of each feeder design. Since there are many different feeder designs in use, it is important to understand the basic principle behind modifying the feeders so that effective modifications can still be carried out when different feeder designs are encountered.

The underlying principle behind each feeder modification is to protect the silicone dome with the cover tape until the LED is ready to be picked up by the nozzle. To achieve this, the cover tape should only be peeled off just before the nozzle picks up the LED (see Figures 20 and 21).

In some instances, the new peeling location is not wide enough. In such cases, the peeling location needs to be widened so that the cover tape can be peeled off without any obstruction (see Figure 23).

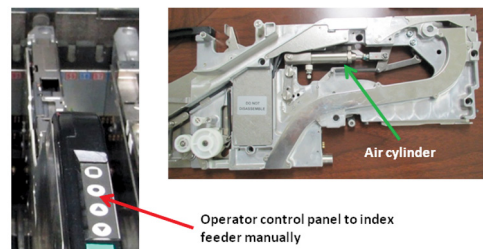

Figure 18: Examples of an electric feeder (left) and a pneumatic feeder (right) which are typically used in pick and place machines to advance the tape with LEDs.

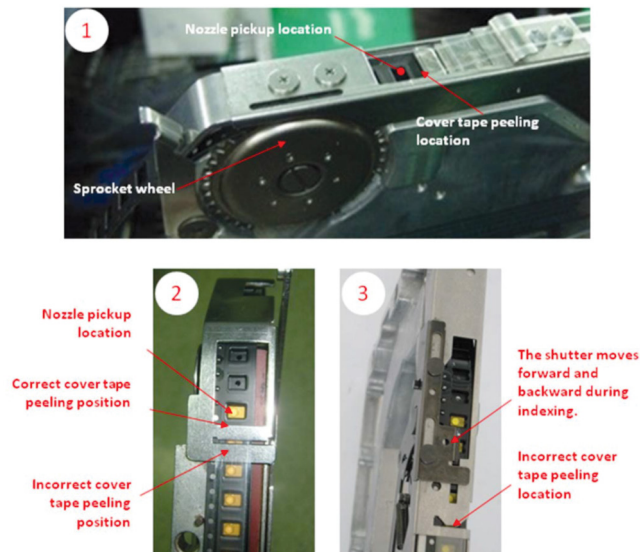

Figure 19: Three representative feeder designs.
 Feeder 1 does not require any modification.
 Feeder 2 requires the cover tape peeling position to be shifted.
 Feeder 3 requires the shutter to be removed before the cover tape peeling position can be adjusted.

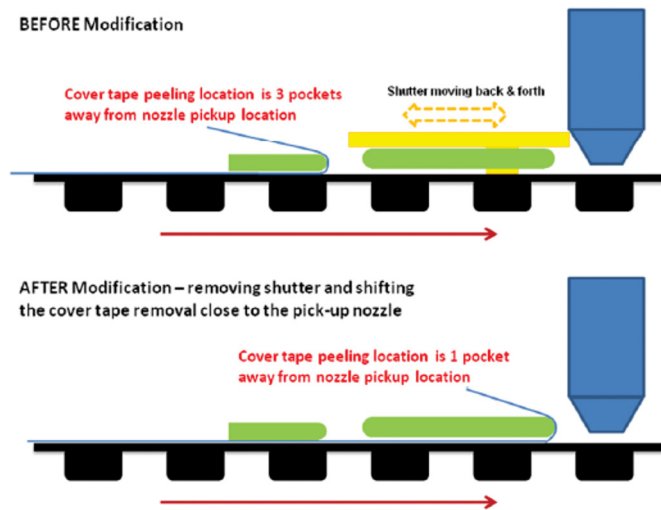

Figure 20: Illustration of the general principle behind the feeder modification.



Figure 21: Example of a modified feeder which protects the silicone dome prior to pickup.

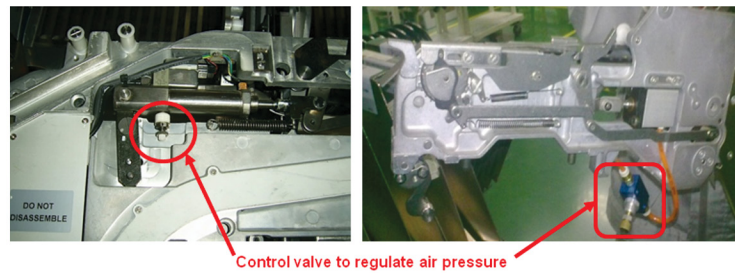

Figure 22: Pneumatic feeder with integrated air pressure control valve (left) and pneumatic feeder with air pressure control valve installed afterwards (right).

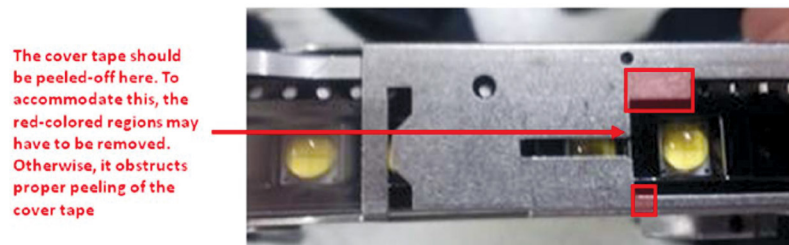

Figure 23: The cover tape peeling location in this feeder needs to be widened so that the cover tape can be peeled off without any obstruction.

To minimize the jerking of components in pneumatic feeders during indexing, it may be necessary to install an air pressure control valve. In some pneumatic feeder designs, such a control valve is already integrated by the machine supplier; in others an external control valve may have to be installed (see Figure 22).

General pick and place machine parameters setup

In general most of the pick and place machines allow an experienced operator to set the settings to obtain high throughput rate and yield. Typical machine parameters that can be adjusted are the nozzle travel speed (xyz motion), timing (e.g. delay time for vacuum on/off), vacuum/air purge control (if adjustable), placement force (e.g. nozzle spring loaded), pattern recognition and pick-up/mount height.

A good starting point on setting up the parameters is based on prior experience with product of similar construction or package size. Additional fine tuning may be required to further optimize the process.

Below is an example of a good starting point on the z-height placement or mount height (Figure 24). The z-height starting point should be $1/3^{\text{rd}}$ of the solder paste thickness. When the LUXEON emitter is in contact with the solder paste, it creates a certain pull force (surface tension) between the pads and the solder paste (liquid) interface. This will aid the release of LUXEON emitter from the tip of the nozzle. In some instances, one can also evaluate releasing the LUXEON emitter just above the solder paste if solder bridging is encountered.

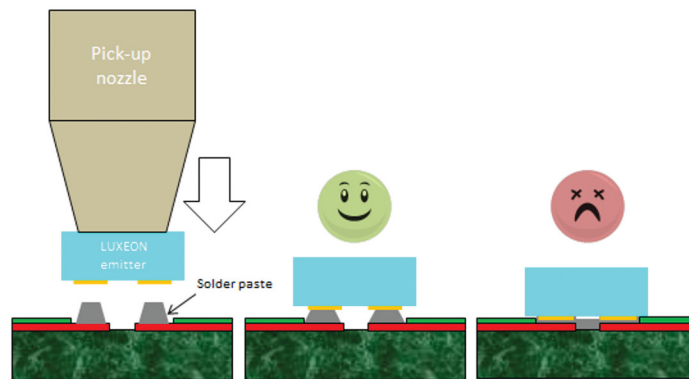

Figure 24: A proper starting point for the mounting z-height of LUXEON emitter is $1/3^{\text{rd}}$ of the stencil thickness with reference to the top of the stencil paste, i.e. the collet should be in an under-travel position. Center picture shows the optimum result for the collet height setting. Right picture shows over-travel position and may result in bridging of the solder paste on adjacent pads prior to reflow.

5.4 Reflow

A standard SMT lead-free reflow profile can be used to reflow LUXEON emitter onto a PCB.

Things to watch for after reflow include:

1. Solder voids (Figure 25) — perform x-ray inspection. Keep solder void to less than 25% coverage of the pad area as recommended by IPC-A-610 “Acceptability of Electronic Assemblies” document)
2. Solder balls. Loose solder balls may move around the PCBs and may cause electrical shorting or reduce creepage distance (refer to IPC-A-610)
3. Any visible damage, tilt or misplacement of LUXEON emitter
4. Change in color and/or reflectivity (i.e. dull appearance) of the solder mask. This may impact the light output extraction or cause color shift.
5. Functional test (open/short)

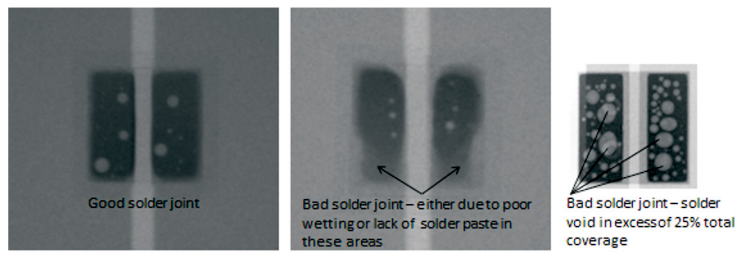

Figure 25: Example of good and bad x-ray result on a two pad LED emitter.

The LUXEON SunPlus 20 emitter has been shown to self-align during the reflow process if the recommended PCB footprint and automated SMT process are used.

5.5 Component Spacing

The minimum allowable spacing between neighboring LUXEON SunPlus 20 packages is 300µm, assuming the recommended LUXEON SunPlus 20 PCB footprint is used and the pick and place machine has a placement accuracy of less than ±50µm.

5.6 Board Handling and Bending

The LED package handling precaution as described in section 1.3 must also be applied when handling completed boards.

Bending of PCBs is a common handling problem seen on large boards. Unlike FR-4 or CEM-3 material, MCPCB and ceramic based PCB should not be bent due to the property of metal and ceramic substrate. For example, when a MCPCB is bent, it is difficult to return it to its original flatness and this could create problems when used in combination with a thermal interface material for good thermal contact.

Bending of FR-4 or CEM-3 board should be kept to minimum to prevent damage to the LUXEON emitter and/or solder joint.

5.7 Rework

Since rework of PCBs typically involves manual processes such as heating up a section of a PCB for repair/component replacement, manual cleaning of PCB pads, manual dispensing of solder paste and manual placement of replacement component, all these can create uncontrollable processes which may yield unpredictable long term performance result. Lumileds currently does not provide any guidelines on how to rework the LUXEON SunPlus 20 emitter.

6. Thermal Measurement Guidelines

6.1 Thermal Basics

This section provides general guidelines on how to determine the junction temperature of a LUXEON emitter in a 1-up configuration in order to verify that the junction temperature in the actual application during regular operation does not exceed the maximum allowable temperature specified in the datasheet.

The typical thermal resistance $R\theta_{j-pad}$ between the junction and the pads for LUXEON emitter is specified in the respective LUXEON emitter datasheet. In LUXEON SunPlus 20, the thermal pad acts as the primary heat flow path. With this information, the junction temperature T_j can be determined according to the following equation:

$$T_j = T_{thermal\ pad} + R\theta_{j-thermal\ pad} \cdot P_{electrical} \quad (1)$$

In this equation $P_{electrical}$ is the electrical power going into the LUXEON emitter and $T_{thermal\ pad}$ is the temperature at the bottom of the LUXEON emitter thermal pad.

6.2 Temperature Sensor Pad (Ts) and Thermocouple (TC) Attachment

In typical applications it may be difficult to measure the thermal pad temperature $T_{\text{thermal pad}}$ directly. Therefore, a practical way to determine the LED junction temperature is by measuring the temperature T_s of a predetermined sensor pad on the PCB right next to the LED package with a thermocouple (TC). The junction temperature can then be calculated as follows:

$$T_j = T_s + R\theta_{j-s} \cdot P_{\text{electrical}} \quad (2)$$

In the above equation $P_{\text{electrical}}$ is the combined electrical power going into the LED package. The thermal resistance from junction to the T_s point, $R\theta_{j-s}$, depends on several factors such as the PCB type and construction (e.g. MCPCB dielectric layer thickness and its thermal conductivity), the location of the T_s point, type and volume of the adhesive used to attach the TC wire, and the LED emitter packing density.

To ensure accurate readings, the TC must make direct contact with the copper of the PCB onto which the LED package pad is soldered, i.e. any solder mask or other masking layer must first be removed before mounting the TC onto the PCB. The TC must be attached as close as possible to the primary heat flow path of the LED emitter pad on PCB as shown in Figure 26.

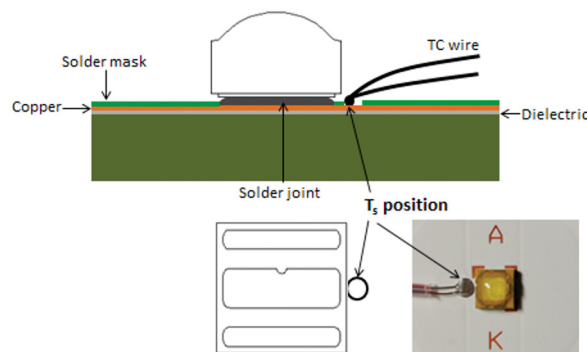

Figure 26: T_s location for LUXEON SunPlus 20 mounted on PCB. Place the TC wire as close as possible to the LUXEON SunPlus 20 thermal pad.

Lumileds has successfully used a two-part Artic Silver™ thermal adhesive in combination with a TC wire gauge of AWG 40 or 36. Excessive dispense of thermal adhesive may impact the accuracy of the T_s temperature reading since this may increase the thermal time constant of the setup (increase in heat capacity of the thermal adhesive). The use of non-conductive thermal epoxy is not recommended since there may be a possibility of getting some epoxy residue underneath the TC wire tip and the exposed PCB copper trace, which will affect the $R\theta_{j-s}$ measurement.

6.3 Thermal Measurement Result

A 1mm thick Al-MCPCB star board with 2oz copper foil, dielectric (thickness of 0.1mm with thermal conductivity of $2.2\text{W}\cdot\text{m}^{-1}\cdot\text{K}^{-1}$) was used in the characterization of the T_s point thermal resistance $R\theta_{j-s}$. The average value of $R\theta_{j-s}$ for LUXEON SunPlus 20 and the overall MCPCB thermal resistance from LED junction to ambient (heat sink) is shown in the Table 3. Using equation (2) the junction temperature can then be calculated.

For other PCB designs and materials, an experiment or thermal simulation may be needed to determine proper $R\theta_{j-s}$ values.

Table 3: Thermal measurement results with the ambient temperature kept at 25°C.

LUXEON SUNPLUS 20	TYPICAL RTH (JUNCTION TO AMBIENT), $R\theta_{j-A}$ (K/W)	TYPICAL RTH (JUNCTION TO TS POINT), $R\theta_{j-s}$ (K/W)
Far Red	10.4	7.6
Deep Red	10.4	7.6
Royal Blue	11.1	8.3
Lime	10.6	7.8
Cool White	10.4	7.6

7. Packaging Considerations—Chemical Compatibility

The LUXEON emitter package contains a silicone overcoat to protect the LED chips and extract the maximum amount of light. As with most silicones used in LED optics, care must be taken to prevent any incompatible chemicals from directly or indirectly reacting with the silicone.

The silicone overcoat in LUXEON emitter is gas permeable. Consequently, oxygen and volatile organic compound (VOC) gas molecules can diffuse into the silicone overcoat. VOCs may originate from adhesives, solder fluxes, conformal coating materials, potting materials and even some of the inks that are used to print the PCBs.

Some VOCs and chemicals react with silicone and produce discoloration and surface damage. Other VOCs do not chemically react with the silicone material directly but diffuse into the silicone and oxidize during the presence of heat or light. Regardless of the physical mechanism, both cases may affect the total LED light output. Since silicone permeability increases with temperature, more VOCs may diffuse into and/or evaporate out from the silicone.

Careful consideration must be given to whether LUXEON emitters are enclosed in an “air tight” environment or not. In an “air tight” environment, some VOCs that were introduced during assembly may permeate and remain in the silicone. Under heat and “blue” light, the VOCs inside the silicone coating may partially oxidize and create an appearance of silicone discoloration, particularly on the surface of the LED where the flux energy is the highest. In an air rich or “open” air environment, VOCs have a chance to leave the area (driven by the normal air flow). Transferring the devices which were discolored in the enclosed environment back to “open” air may allow the oxidized VOCs to diffuse out of the silicone and may restore the original optical properties of the LED.

Determining suitable threshold limits for the presence of VOCs is very difficult since these limits depend on the type of enclosure used to house the LEDs and the operating temperatures. Also, some VOCs can photo-degrade over time.

Table 4 provides a list of commonly used chemicals that should be avoided as they may react with the silicone material. Note that Lumileds does not warrant that this list is exhaustive since it is impossible to determine all chemicals that may affect LED performance.

The chemicals in Table 4 are typically not directly used in the final products that are built around LUXEON emitter. However, some of these chemicals may be used in intermediate manufacturing steps (e.g. cleaning agents). Consequently, trace amounts of these chemicals may remain on (sub) components, such as heat sinks or on PCBs. Lumileds, therefore, recommends the following precautions when designing your application:

- When designing secondary lenses to be used over an LED, provide a sufficiently large air-pocket and allow for “ventilation” of this air away from the immediate vicinity of the LED.
- Use mechanical means of attaching lenses and circuit boards as much as possible. When using adhesives, potting compounds and coatings, carefully analyze its material composition and do thorough testing of the entire fixture under High Temperature over Life (HTOL) conditions.

Table 4: List of commonly used chemicals that will damage the silicone overcoat of the LUXEON emitter. Avoid using any of these chemicals in the housing that contains the LED package.

CHEMICAL NAME	NORMALLY USED AS
Hydrochloric acid	acid
Sulfuric acid	acid
Nitric acid	acid
Acetic acid	acid
Sodium hydroxide	alkali
Potassium hydroxide	alkali
Ammonia	alkali
MEK (Methyl Ethyl Ketone)	solvent
MIBK (Methyl Isobutyl Ketone)	solvent
Toluene	solvent
Xylene	solvent
Benzene	solvent
Gasoline	solvent
Mineral spirits	solvent
Dichloromethane	solvent
Tetrachlorometane	solvent
Castor oil	oil
Lard	oil
Linseed oil	oil
Petroleum	oil
Silicone oil	oil
Halogenated hydrocarbons (containing F, Cl, Br elements)	misc
Rosin flux	solder flux
Acrylic tape	adhesive



About Lumileds

Lumileds is the global leader in light engine technology. The company develops, manufactures and distributes groundbreaking LEDs and automotive lighting products that shatter the status quo and help customers gain and maintain a competitive edge.

With a rich history of industry “firsts,” Lumileds is uniquely positioned to deliver lighting advancements well into the future by maintaining an unwavering focus on quality, innovation and reliability.

To learn more about our portfolio of light engines, visit lumileds.com.



©2016 Lumileds Holding B.V. All rights reserved.
LUXEON is a registered trademark of the Lumileds Holding B.V.
in the United States and other countries.

lumileds.com

Neither Lumileds Holding B.V. nor its affiliates shall be liable for any kind of loss of data or any other damages, direct, indirect or consequential, resulting from the use of the provided information and data. Although Lumileds Holding B.V. and/or its affiliates have attempted to provide the most accurate information and data, the materials and services information and data are provided “as is,” and neither Lumileds Holding B.V. nor its affiliates warrants or guarantees the contents and correctness of the provided information and data. Lumileds Holding B.V. and its affiliates reserve the right to make changes without notice. You as user agree to this disclaimer and user agreement with the download or use of the provided materials, information and data..