

LUXEON Altilon Intense 1x2

Industry-leading solutions for compact high performance headlight systems

LUXEON Altilon Intense LEDs, with their miniaturized form factor, are designed to support low and high beam applications. The Lumileds automotive binning structure meets both SAE and ECE color specifications and is hot binned at 85 °C, consistent with actual automotive operational environments. All LUXEON Altilon Intense LEDs are AEC-Q102 qualified.

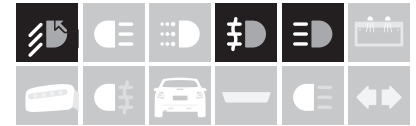

FEATURES AND BENEFITS

Standard packaging for low cost and ease of manufacturability

Hot binned at 85 °C MP to match closer to operating conditions

IEC/PAS 62707-1 White LED

PRIMARY APPLICATIONS

Adaptive Lighting

- AFS

- Matrix Beam

Headlight

- Low Beam

- High Beam

Table of Contents

General Product Information	2
Product Test Conditions	2
Part Number Nomenclature	2
Environmental Compliance	3
Performance Characteristics	3
Product Selection Guide	3
Optical Characteristics	3
Electrical and Thermal Characteristics	4
Absolute Ratings	4
JEDEC Moisture Sensitivity	4
Characteristic Curves	5
Spectral Power Distribution Characteristics	5
Light Output Characteristics	5
Forward Current and Voltage Characteristics	6
Color Shift Characteristics	7
Radiation Pattern Characteristics	9
Operating Limits Characteristics	9
Permissible Pulse Handling Characteristic	10
Product Bin and Labeling Definitions	11
Designing with LUXEON Altilon Intense Gen2 1x2	11
Decoding Product Bin Labeling	11
Luminous Flux Bins	11
Color Codes	12
Color Bin Definitions	13
Color Bin Definitions	14
Forward Voltage Bins	15
Mechanical Dimensions	15
Packaging and Labeling Information	16
Pocket Tape Dimensions	16
Reel Dimensions	16
Product Labeling	17

General Product Information

Product Test Conditions

LUXEON Altilon Intense Gen2 1x2 is binned using a <20 ms monopulse (MP) at 1500 mA drive current. The case temperature T_c is set to 85 °C at the beginning of the pulse. Unless otherwise noted, the same test conditions apply to all data in this document.

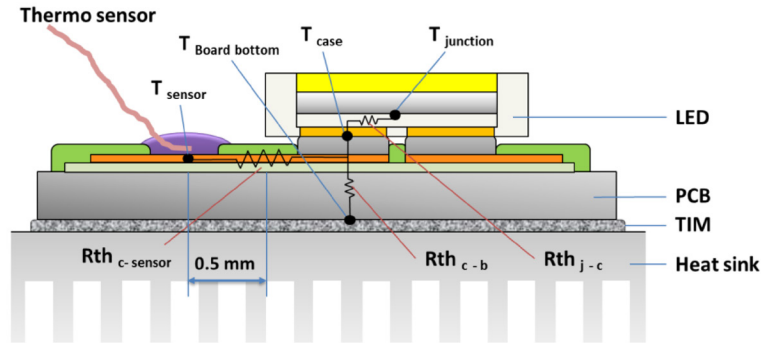

Figure 1. Case temperature measurement point for LUXEON Altilon Intense Gen2 1x2

Part Number Nomenclature

Part numbers for LUXEON Altilon Intense Gen2 1x2 follow the convention below:

A 1 S L – 5 8 5 0 B D H 2 G G G G 0

Where:

- A 1** – designates Automotive LED
- S** – designates product line/family (S = SMD)
- L** – designates LUXEON Altilon Intense product family
- B B B B** – designates color temperature
- C** – designates number of die/chip (2 = 1 die)
- D** – designates binning current (E = 1500 mA)
- E** – designates binning condition (H = 85 °C)
- F** – designates options for detailed product specification (default 0)
- G G G G** – designates minimum luminous flux bin or custom part number
- H** – designates options for detailed product specification (default 0)

Therefore, the following part number is used for a LUXEON Altilon Intense Gen2 1x2 with a minimum luminous flux of 740 lumens:

A 1 S L – 5 8 5 0 2 E H 2 0 7 4 0 0

Environmental Compliance

Lumileds LLC is committed to providing environmentally friendly products to the solid-state lighting market. LUXEON Alticon Intense Gen2 1x2 is compliant to the European Union directives on the restriction of hazardous substances in electronic equipment, namely the RoHS Directive 2011/65/EU and REACH Regulation (EC) 1907/2006. Lumileds LLC will not intentionally add the following restricted materials to its products: lead, mercury, cadmium, hexavalent chromium, polybrominated biphenyls (PBB) or polybrominated diphenyl ethers (PBDE).

Performance Characteristics

Product Selection Guide

Table 1. Product selection for LUXEON Alticon Intense Gen2 1x2

MINIMUM LUMINOUS FLUX ^[1] (lm)	PART NUMBER
680	A1SL-58502EH206800
700	A1SL-58502EH207000
720	A1SL-58502EH207200
740	A1SL-58502EH207400
760	A1SL-58502EH207600
780	A1SL-58502EH207800
800	A1SL-58502EH208000

Notes for Table 1:

1. Lumileds maintains a tolerance of $\pm 6.5\%$ on luminous flux measurements.

Optical Characteristics

Table 2. Typical optical characteristics for LUXEON Alticon Intense Gen2 1x2

PART NUMBER	CORRELATED COLOR TEMPERATURE ^[1] (K)		TYPICAL TOTAL INCLUDED ANGLE ^[2] $\theta_{0.90V}$	TYPICAL VIEWING ANGLE ^[3] $2\theta_{1/2}$
	MINIMUM	MAXIMUM		
A1SL-58502EH2xxxx0	5180	6680	140°	120°

Notes for Table 2:

1. Correlated color temperature is measured at binning condition.

2. $2\theta_{0.90V}$ denotes the total angle at which 90% of total luminous flux is captured, i.e. the cone defined by the off-axis angle $\theta_{0.90V}$ from the LED centerline includes 90% of the total flux.

3. $2\theta_{1/2}$ denotes the viewing angle, with $\theta_{1/2}$ being the off-axis angle from the LED centerline where the luminous intensity is $\frac{1}{2}$ of the peak value.

Electrical and Thermal Characteristics

Table 3. Typical electrical and thermal characteristics for LUXEON Altilon Intense Gen2 1x2

PART NUMBER	THERMAL RESISTANCE JUNCTION-TO-CASE (K/W)			
	$R\theta_{j-c\text{ el}}^{[1]}$		$R\theta_{j-c\text{ real}}^{[2]}$	
	TYPICAL	MAXIMUM	TYPICAL	MAXIMUM
A1SL-58502EH2xxxx0	3.1	3.9	4.1	5.1

Notes for Table 3:

1. Ratio between temperature difference (junction->case) and electrical input power (references JE5D51-51, JE5D51-14).
2. Ratio between temperature difference (junction->case) and dissipated heat, i.e. emitted light taken into account (references JE5D51-51, JE5D51-14).

Absolute Ratings

Table 4. Absolute ratings for LUXEON Altilon Intense Gen2 1x2

PARAMETER	PERFORMANCE
Minimum DC Forward Current	50 mA
Maximum DC Forward Current	1600 mA
Maximum Junction Temperature ^[1,2]	150 °C
Maximum Junction Temperature for Short Time Applications ^[3]	180 °C
Case Temperature Range ^[1]	-40 °C to 135 °C
LED Storage Temperature	-40 °C to 135 °C
Soldering Temperature	JEDEC 020c 260 °C
ESD Sensitivity ^[4]	±8 kV HBM, ±1 kV CDM
Reverse Voltage (V_{reverse})	LUXEON LEDs are not designed to be driven in reverse bias

Notes for Table 4:

1. Proper current derating must be observed to maintain junction temperature below the maximum allowable temperature. LUXEON Altilon Intense Gen2 1x2 LEDs driven at or above maximum LED case temperature may have shorter lifetime.
2. Please consult with Lumileds for more information on maximum time durations and forward currents for these temperatures.
3. Short time operations of less than 200 hours.
4. Measured using human body model (per ANSI/ANSI/ESDA/JEDEC JS-001-2010), charged device model (AEC Q101-005 rev A).

JEDEC Moisture Sensitivity

Table 5. Moisture sensitivity levels for LUXEON Altilon Intense Gen2 1x2

LEVEL	FLOOR LIFE		STANDARD SOAK REQUIREMENTS	
	TIME	CONDITIONS	TIME	CONDITIONS
1	Unlimited	≤30 °C / 85% RH	168 Hours +5 / -0	85 °C / 85% RH

Characteristic Curves

Spectral Power Distribution Characteristics

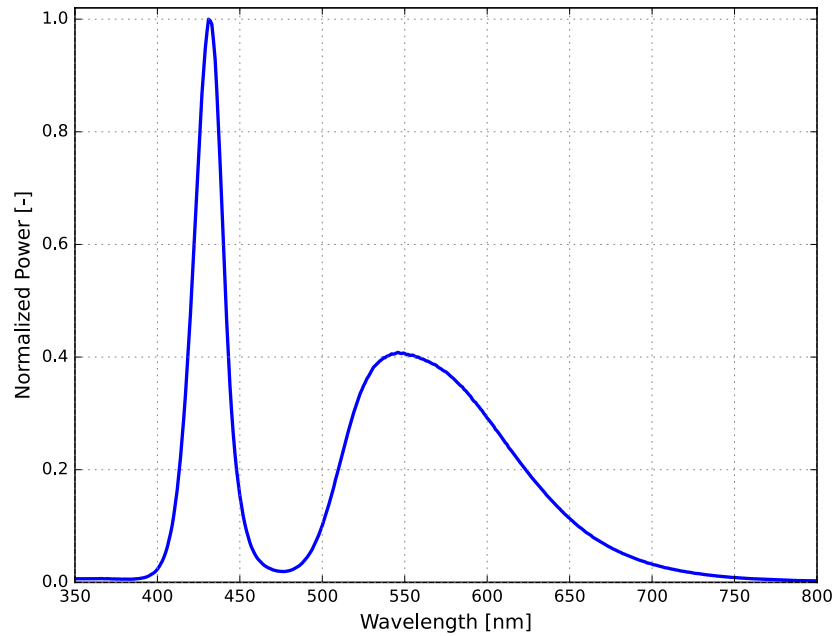

Figure 2. Typical normalized power vs. wavelength for LUXEON Altilon Intense Gen2 1x2, 1500 mA MP, $T_c = 85^\circ\text{C}$

Light Output Characteristics

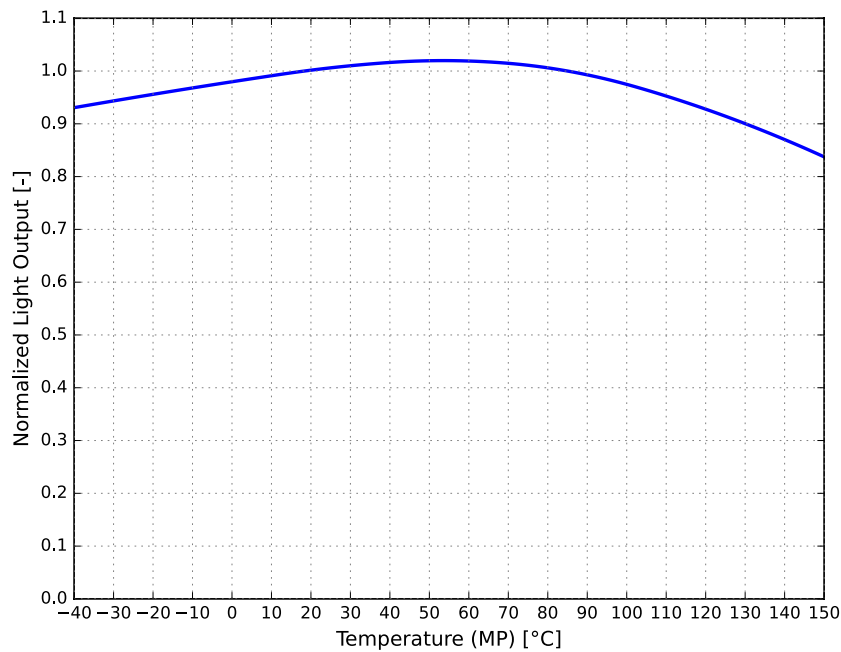

Figure 3a. Typical normalized light output vs. case temperature for LUXEON Altilon Intense Gen2 1x2, 1500 mA MP

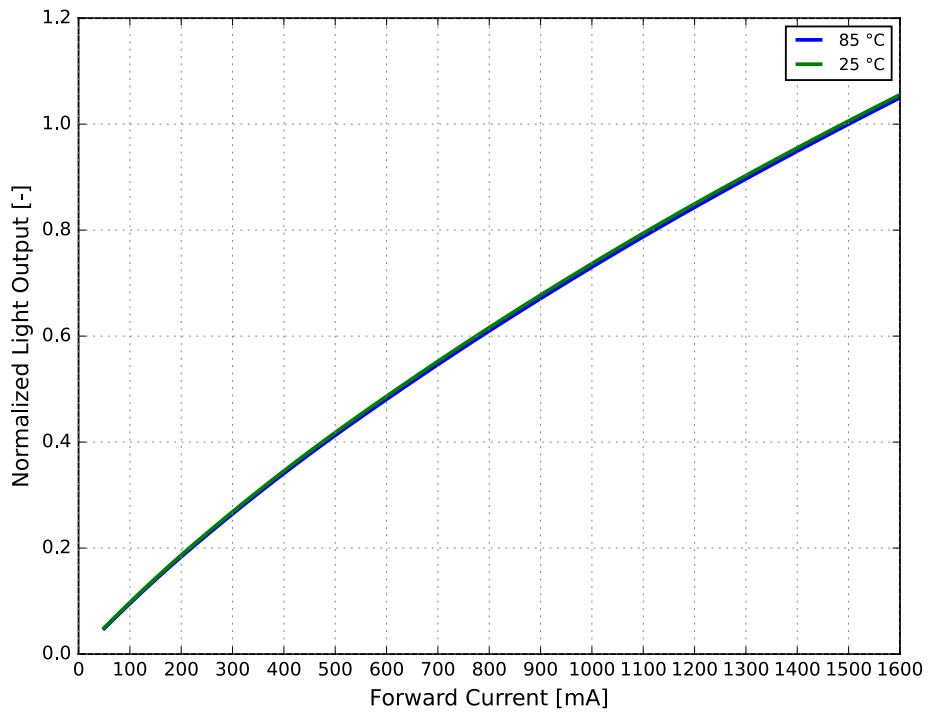

Figure 3b. Typical normalized light output vs. forward current for LUXEON Altilon Intense Gen2 1x2, MP, 25 °C and $T_c = 85\text{ °C}$

Forward Current and Voltage Characteristics

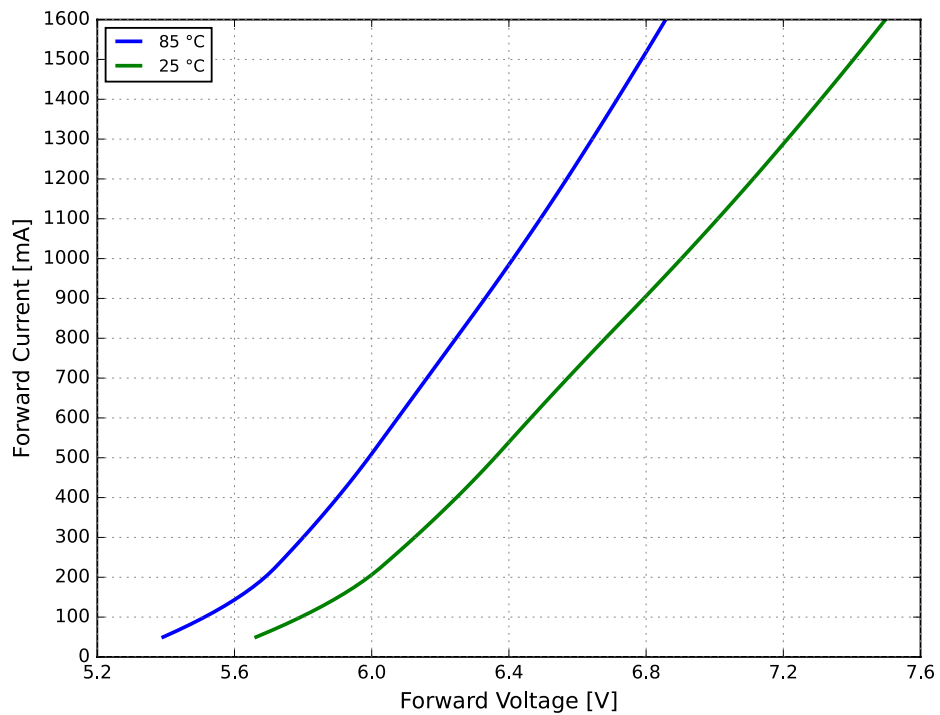

Figure 4a. Typical forward current vs. forward voltage for LUXEON Altilon Intense Gen2 1x2, MP, 25 °C and $T_c = 85\text{ °C}$

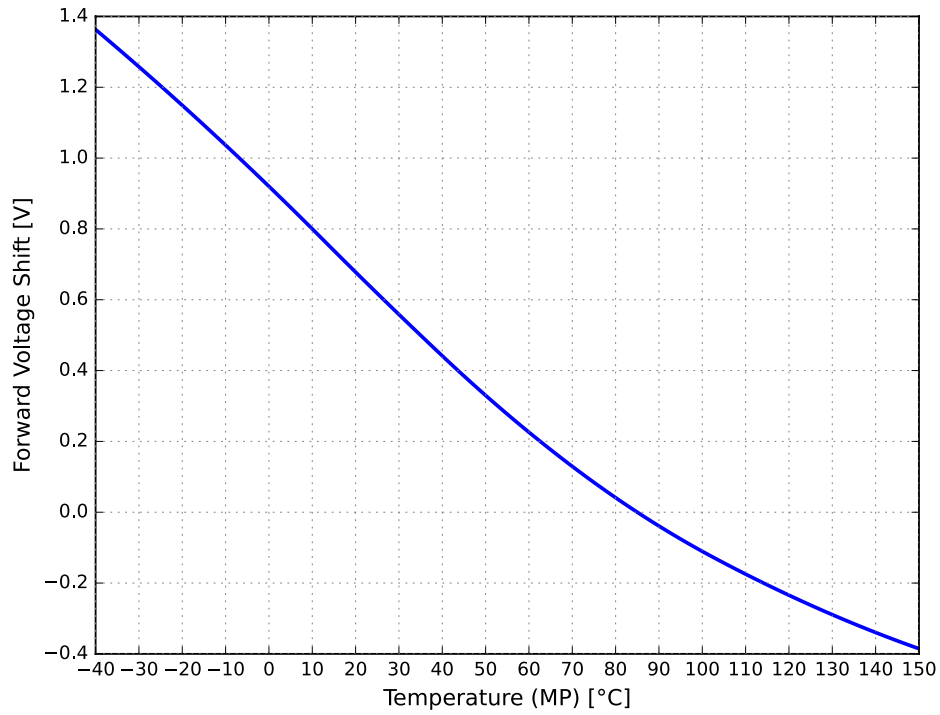

Figure 4b. Typical forward voltage vs. case temperature for LUXEON Altilon Intense Gen2 1x2, 1500 mA MP

Color Shift Characteristics

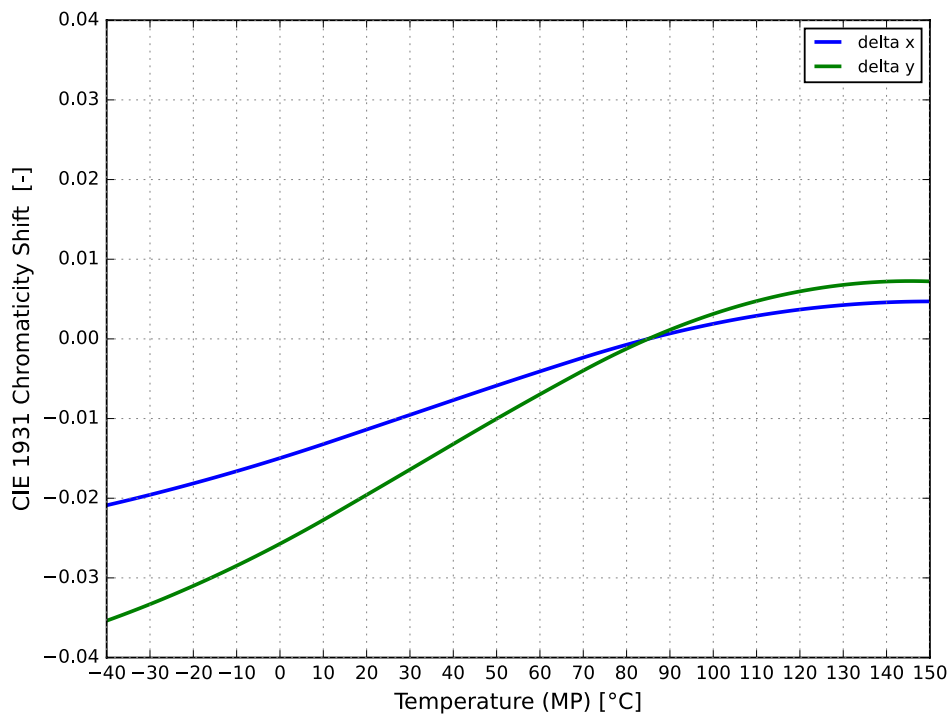

Figure 5a. Typical color shift in CIE 1931 x and y coordinates vs. case temperature for LUXEON Altilon Intense Gen2 1x2

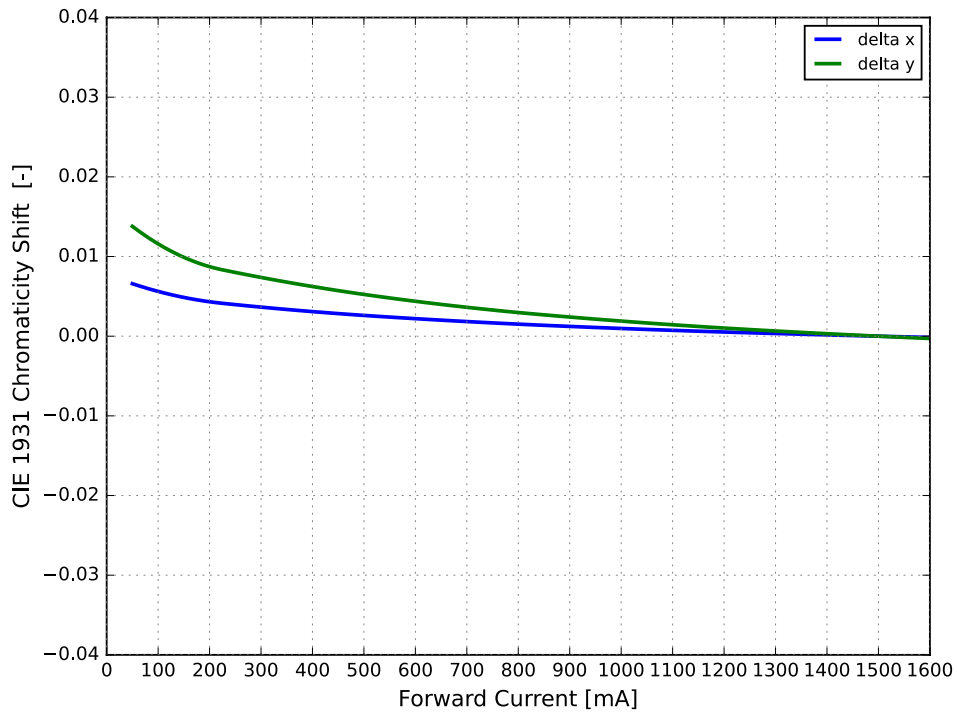

Figure 5b. Typical color shift in CIE 1931 x and y coordinates vs. forward current for LUXEON Altilon Intense Gen2 1x2, $T_c = 85\text{ }^\circ\text{C}$

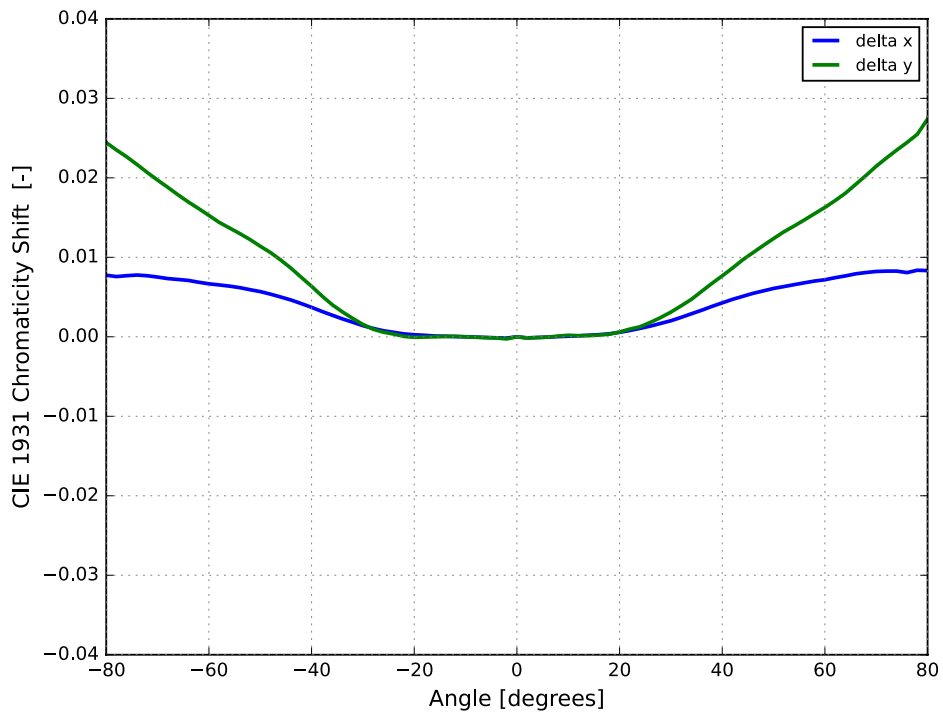

Figure 5c. Typical color shift in CIE 1931 x and y coordinates vs. angle for LUXEON Altilon Intense Gen2 1x2

Radiation Pattern Characteristics

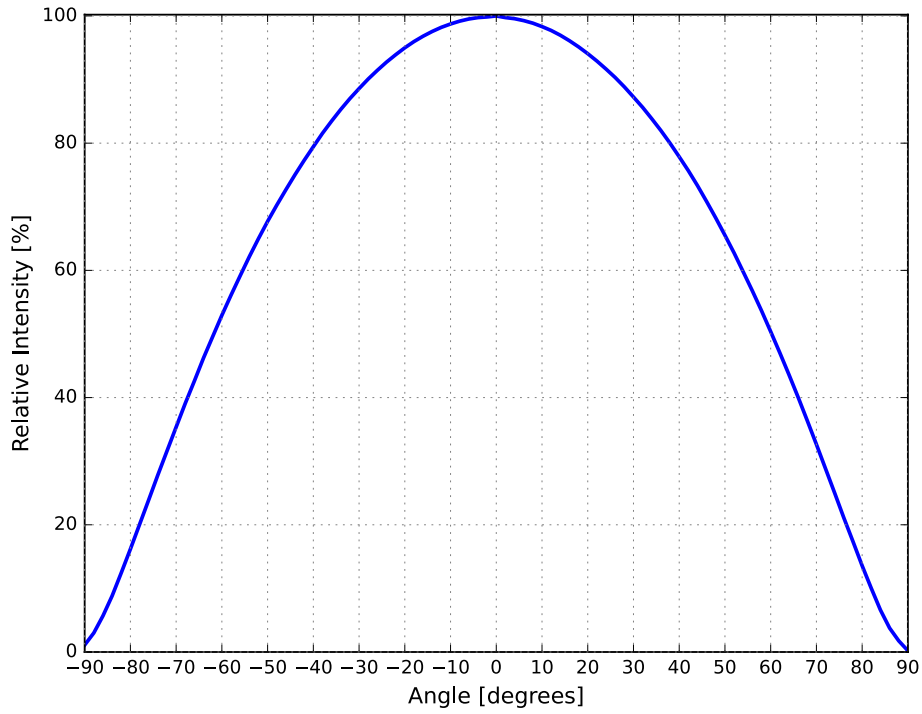

Figure 6. Typical radiation pattern for LUXEON Altilon Intense Gen2 1x2

Operating Limits Characteristics

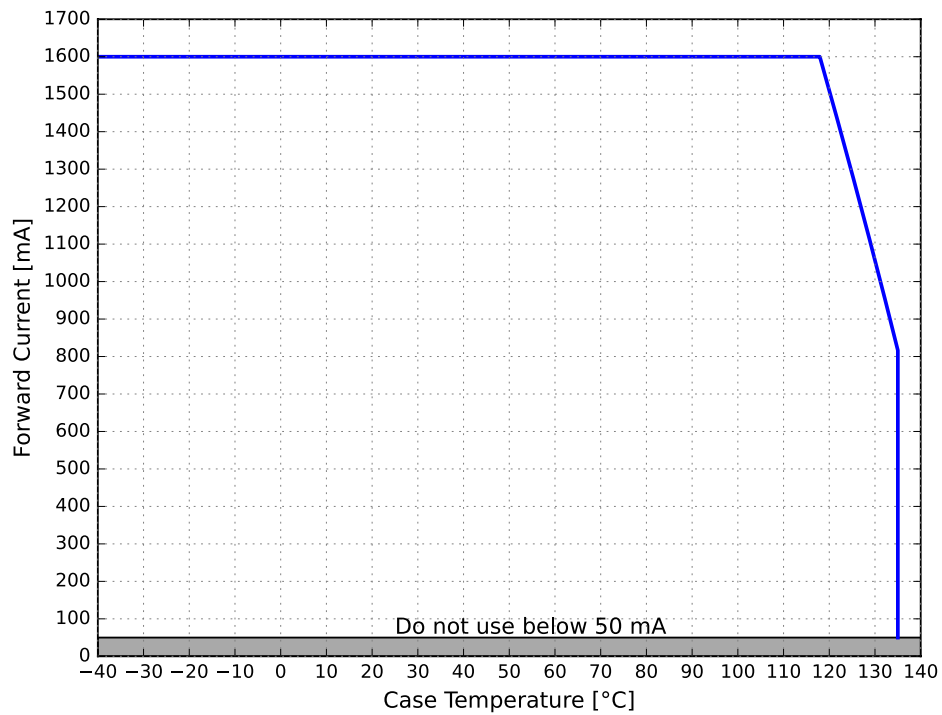

Figure 7. Maximum forward current vs. case temperature for LUXEON Altilon Intense Gen 2 1x2

Permissible Pulse Handling Characteristic

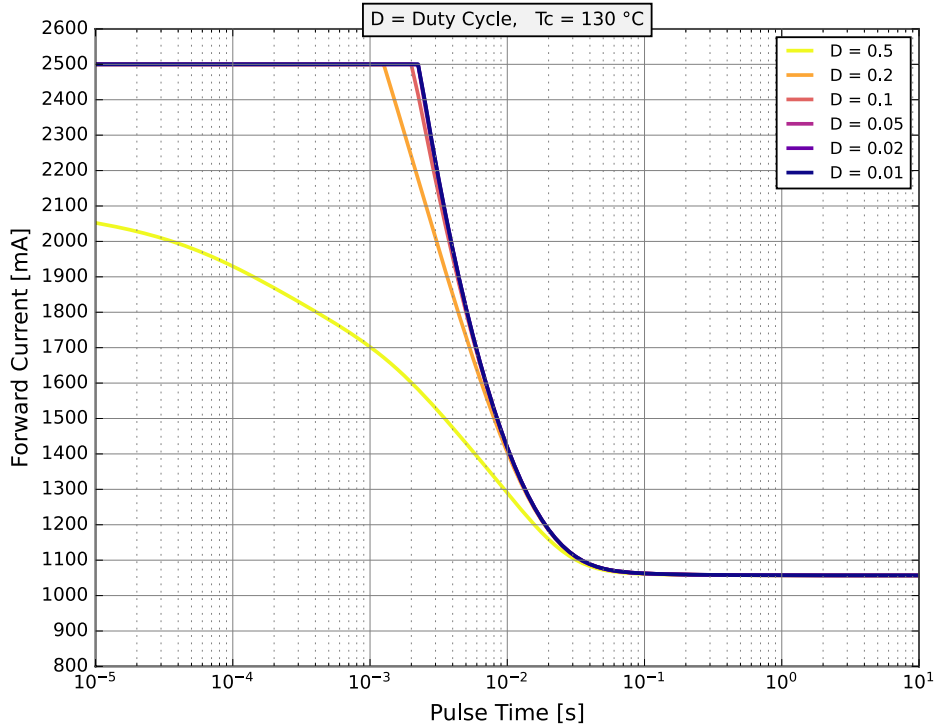

Figure 8. Permissible pulse handling capability for LUXEON Altilon Intense Gen2 1x2

Product Bin and Labeling Definitions

Designing with LUXEON Altilon Intense Gen2 1x2

Flux bins supportable for car programs depend on product color and program start-of-production and end-of-production dates. Flux roadmaps by year and product color are maintained and available from the sales representative. Please contact a local sales representative to request the flux bin range with best supportability for program timing.

Decoding Product Bin Labeling

In the manufacturing of semiconductor products, there are variations in performance around the average values given in the technical datasheet. For this reason, Lumileds bins LED components for luminous flux, color and forward voltage.

LUXEON Altilon Intense Gen2 1x2 LEDs are labeled using a 4-digit alphanumeric CAT code following the format below:

A B C D

Where:

- A** – designates luminous flux bin (example: Q = 370 to 380 lumens) per die
- B C** – designates color bin (example: H2, HC, H3, H5)
- D** – designates forward voltage bin (example: B = 6.4 to 7.0 V)

Therefore, a LUXEON Altilon Intense Gen2 1x2 with a lumen range of 370 to 380 lm, color bin of HC, and a forward voltage range of 6.4 to 7.0 V has the following CAT code:

Q H C B

Luminous Flux Bins

Table 6 lists the standard luminous flux bins for LUXEON Altilon Intense Gen2 1x2 emitters. To obtain the flux of the product this number needs to be multiplied with the chip count. Product availability in a particular bin varies by color and platform start-of-production date. Contact your local sales representative for best supportability of programs.

Table 6. Luminous flux bin definitions for LUXEON Altilon Intense Gen2 1x2, 1500 mA MP, $T_c = 85^\circ\text{C}$

BIN	LUMINOUS FLUX ⁽¹⁾ (lm)	
	MINIMUM	MAXIMUM
M	340	350
N	350	360
P	360	370
Q	370	380
R	380	390
S	390	400
T	400	410

Notes for Table 6:

1. Lumileds maintains a tolerance of $\pm 6.5\%$ on luminous flux measurements.

Color Codes

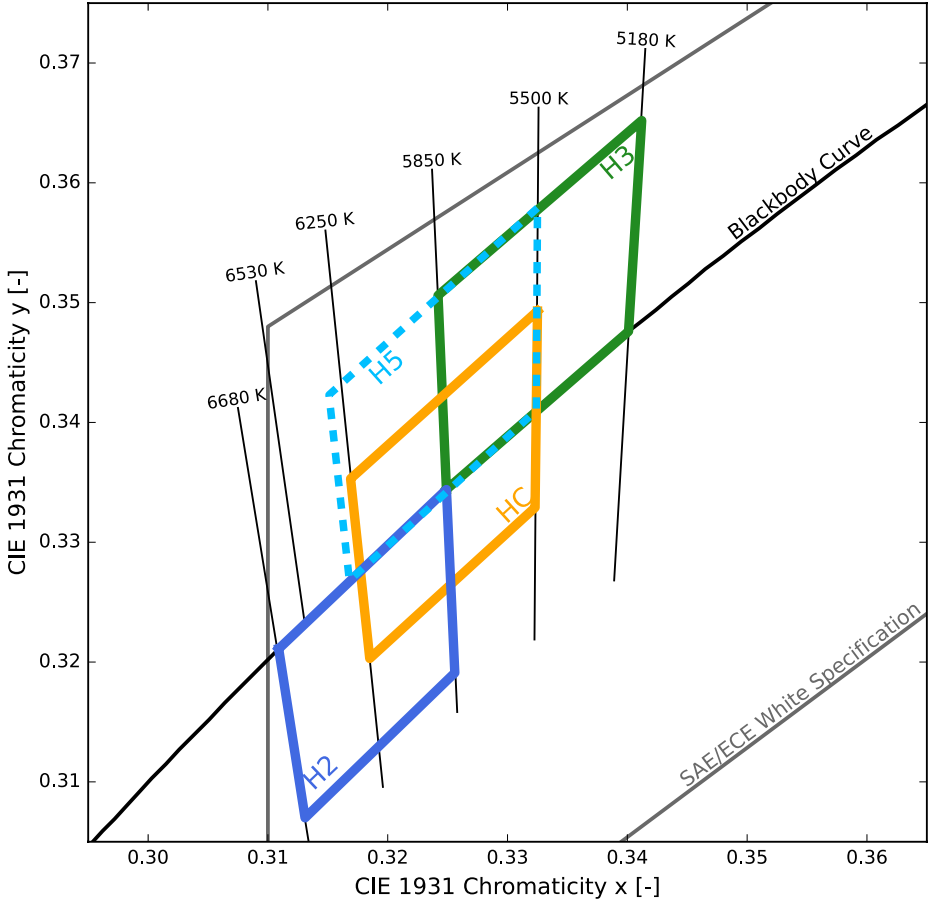

Figure 9. Color bin structure in CIE 1931 color space for LUXEON Altilon Intense Gen2 1x2 at 1500 mA, 20 ms MP, $T_c = 85\text{ }^\circ\text{C}$

Notes for Figures 9:
 1. Lumileds supports the following bins for LUXEON Altilon Intense Gen2 1x2 : H2, HC, H3, H5

Color Bin Definitions

Table 7. Color bin definitions for LUXEON Altilon Intense Gen2 1x2

BIN	x ^[1, 2]	y ^[1, 2]	TYPICAL CCT (K)
HC	0.3325	0.3493	5850
	0.3169	0.3353	
	0.3185	0.3203	
	0.3323	0.3329	
H5	0.3325	0.3579	5900
	0.3151	0.3423	
	0.3168	0.3268	
	0.3324	0.3410	
H2	0.3109	0.3211	6250
	0.3131	0.3070	
	0.3256	0.3191	
	0.3249	0.3344	
H3	0.3249	0.3344	5500
	0.3401	0.3476	
	0.3412	0.3652	
	0.3242	0.3506	

Notes for Table 7:

1. Lumileds maintains a tester tolerance of ±0.005 on x and y color coordinates.
2. CIE 1931 x and y coordinate frame.

Color Bin Definitions

Table 7a. Color bin definitions for LUXEON Altilon Intense Gen2 1x2

BIN	x ^[1, 2]	y ^[1, 2]	6-DIGIT IEC CODE ^[3]	TYPICAL CCT (K)	BIN	x ^[1, 2]	y ^[1, 2]	6-DIGIT IEC CODE ^[3]	TYPICAL CCT (K)
1A	0.3109	0.3382	fbwD23	6390	3A	0.3242	0.3506	fcbD33	5680
	0.3161	0.3432				0.3325	0.3579		
	0.3169	0.3353				0.3325	0.3493		
	0.3120	0.3306				0.3246	0.3424		
1B	0.3120	0.3306	fbwA23	6390	3B	0.3246	0.3424	fcbA33	5680
	0.3169	0.3353				0.3325	0.3493		
	0.3177	0.3277				0.3324	0.3410		
	0.3131	0.3232				0.3249	0.3344		
1C	0.3161	0.3432	fbyD33	6050	3C	0.3325	0.3579	fceD33	5350
	0.3242	0.3506				0.3412	0.3652		
	0.3246	0.3424				0.3406	0.3562		
	0.3169	0.3353				0.3325	0.3493		
1D	0.3169	0.3353	fbyA33	6050	3D	0.3325	0.3493	fceA33	5350
	0.3246	0.3424				0.3406	0.3562		
	0.3249	0.3344				0.3401	0.3476		
	0.3177	0.3277				0.3324	0.3410		
2A	0.3109	0.3211	ebvD33	6460	4A	0.3249	0.3266	ecbD33	5680
	0.3177	0.3277				0.3324	0.3329		
	0.3185	0.3203				0.3323	0.3251		
	0.3120	0.3139				0.3256	0.3191		
2B	0.3120	0.3139	ebvG33	6460	4B	0.3253	0.3266	ecbG33	5680
	0.3185	0.3203				0.3323	0.3329		
	0.3192	0.3131				0.3323	0.3251		
	0.3131	0.3070				0.3256	0.3191		
2C	0.3177	0.3277	ebyD33	6050	4C	0.3324	0.3410	eceD33	5350
	0.3249	0.3344				0.3401	0.3476		
	0.3253	0.3366				0.3396	0.3392		
	0.3185	0.3203				0.3323	0.3329		
2D	0.3185	0.3203	ebyG33	6050	4D	0.3323	0.3329	eceG33	5350
	0.3253	0.3266				0.3396	0.3329		
	0.3256	0.3191				0.3392	0.3310		
	0.3192	0.3131				0.3323	0.3251		

Notes for Table 7a:

1. Lumileds maintains a tester tolerance of ±0.005 on x and y color coordinates.
2. CIE 1931 x and y coordinate frame.
3. Per IEC/ PAS 62707-1.

Forward Voltage Bins

Table 8. Forward voltage bin definitions for LUXEON Altilon Intense Gen2 1x2

BIN	FORWARD VOLTAGE ⁽¹⁾ (V _f)	
	MINIMUM	MAXIMUM
A	5.80	6.40
B	6.40	7.00
C	7.00	7.60

Notes for Table 8:

1. Lumileds maintains a tolerance of $\pm 0.06V$ on forward voltage measurements.
2. Several bins are outlined; product availability in a particular bin varies by production run and product performance.

Mechanical Dimensions

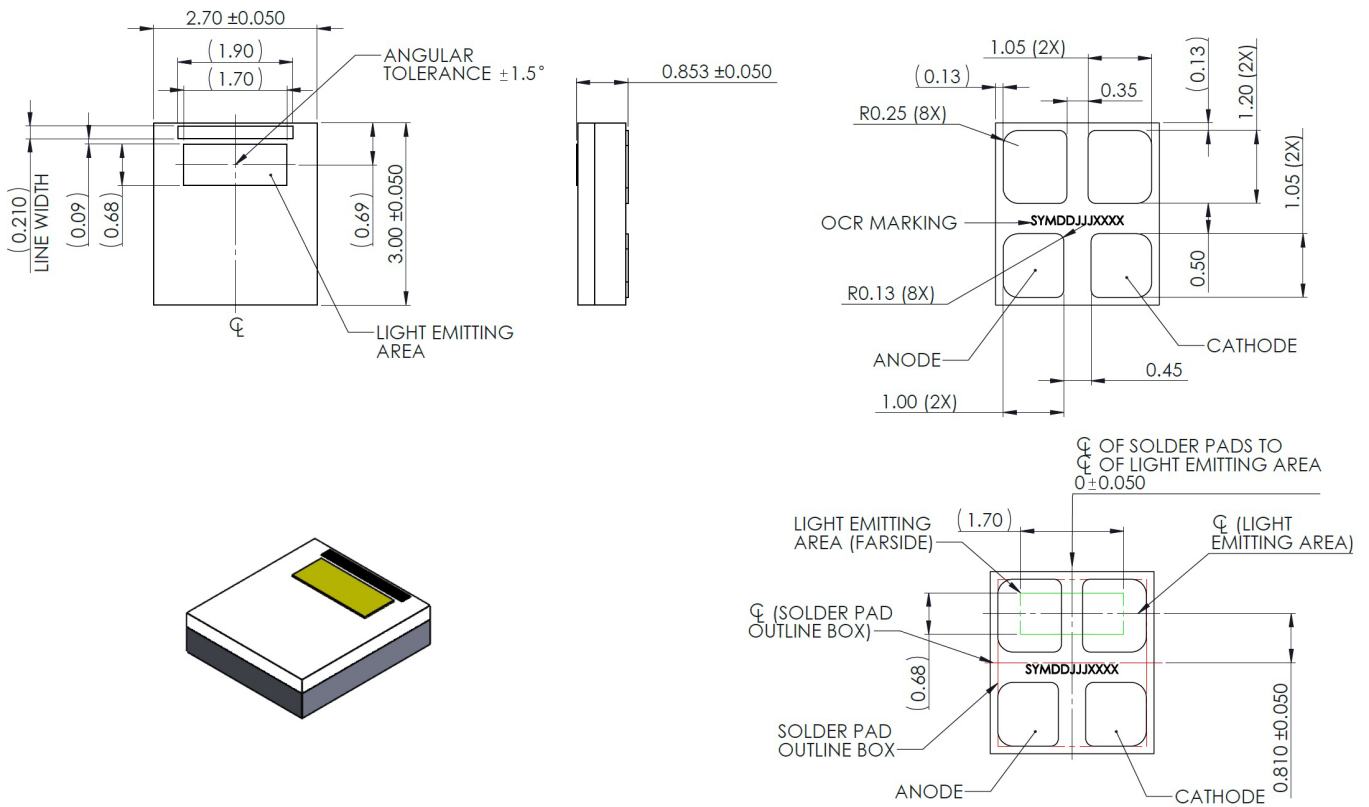

Figure 10. Mechanical dimensions for LUXEON Altilon Intense Gen2 1x2

Notes for Figure 10:

1. Drawings are not to scale.
2. All dimensions are in millimeters.

Packaging and Labeling Information

Pocket Tape Dimensions

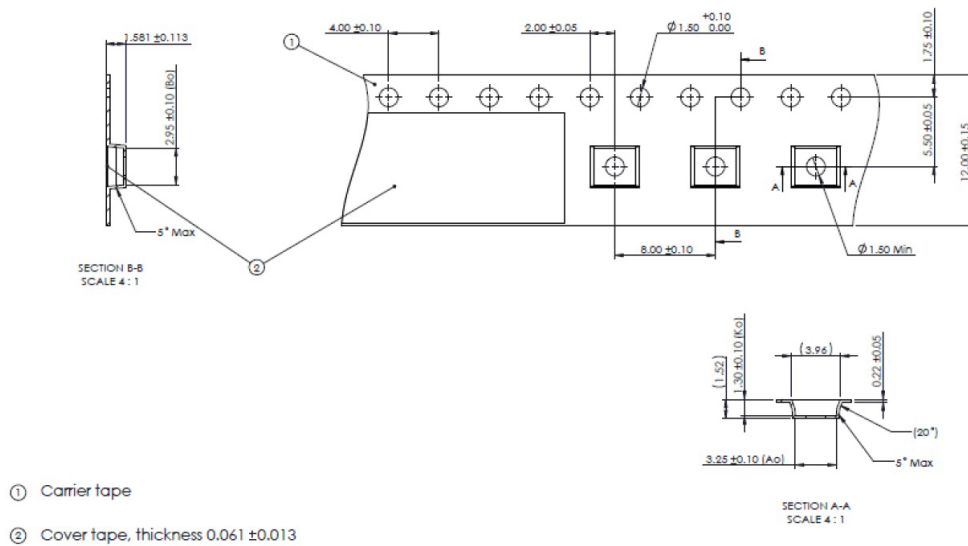

Figure 11. Pocket tape dimensions for LUXEON Altilon Intense Gen2 1x2

Notes for Figure 11:

1. Drawings are not to scale.
2. All dimensions are in millimeters.

Reel Dimensions

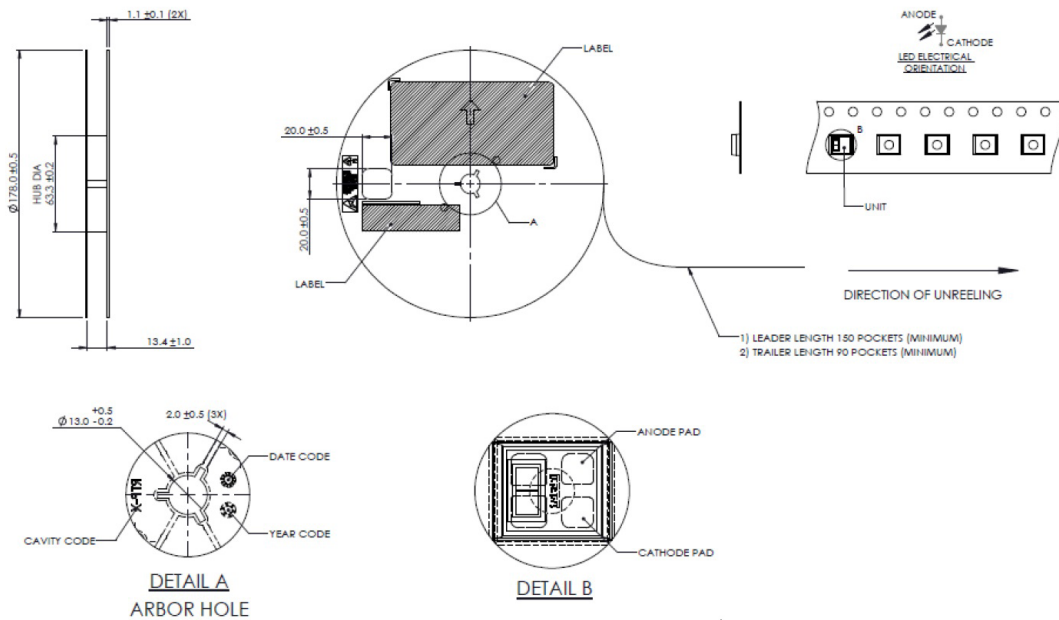

Figure 12. Reel dimensions for LUXEON Altilon Intense Gen2 1x2

Notes for Figure 12:

1. Drawings are not to scale.
2. All dimensions are in millimeters.

Product Labeling



	(MN) Material Number: 000927701992001	
(1) —	(Q) Quantity: 1000	MSL 1
		Reflow temp 260 °C max
(2) —	(1P) Material Desc.: A1SL-58502EH207800	
(3) —	(P) Customer Product ID: 793.815-00	
(4) —	(9D) Date code: 1837	(S) Prod. order: 111138250
	(PI) Pattern: B09202018	
		H/F RoHS Compliant
(5) —	(1T) Lot ID: 180910607095	(6) — (4L) COO: MY
		(33P) Cat code: QHCB — (7)

Figure 13. Example of box label for LUXEON Altilon Intense

Notes for Figure 13 – Box Label descriptions for customer use:

Field labels not described are for Lumileds internal use only.

1. Total number of LED emitters in a shipment box.
2. Lumileds part number.
3. Customer part number for costum requests only.
4. LED test date in YYWW format.
5. Unique product lot identification number. This number is required for traceability purposes.
6. Country code of origin of manufacturing of part (e.g. MY for Malaysia, CN for China) according to ISO 3166-1 alpha-2 document.
7. Product bin 4-digit alphanumeric CAT code.

About Lumileds

Companies developing automotive, mobile, IoT and illumination lighting applications need a partner who can collaborate with them to push the boundaries of light. With over 100 years of inventions and industry firsts, Lumileds is a global lighting solutions company that helps customers around the world deliver differentiated solutions to gain and maintain a competitive edge. As the inventor of Xenon technology, a pioneer in halogen lighting and the leader in high performance LEDs, Lumileds builds innovation, quality and reliability into its technology, products and every customer engagement. Together with its customers, Lumileds is making the world better, safer, more beautiful—with light.

To learn more about our lighting solutions, visit lumileds.com.



©2022 Lumileds Holding B.V. All rights reserved.
LUXEON is a registered trademark of the Lumileds Holding B.V. in the United States and other countries.

lumileds.com

Neither Lumileds Holding B.V. nor its affiliates shall be liable for any kind of loss of data or any other damages, direct, indirect or consequential, resulting from the use of the provided information and data. Although Lumileds Holding B.V. and/or its affiliates have attempted to provide the most accurate information and data, the materials and services information and data are provided "as is," and neither Lumileds Holding B.V. nor its affiliates warrants or guarantees the contents and correctness of the provided information and data. Lumileds Holding B.V. and its affiliates reserve the right to make changes without notice. You as user agree to this disclaimer and user agreement with the use of the provided materials, information and data. A listing of Lumileds product/patent coverage may be accessed at lumileds.com/patents.