

SignalSure 250

High power SMD solution

SignalSure 250 is a compact, surface-mount, high power LED signaling solution that delivers an elevated standard of light output, flux density, and color uniformity. SignalSure's robust design structure, coupled with high performance specifications, ensures high quality and reliability. SignalSure 250 is IEC-60810 and AEC-Q102 qualified.

SignalSure 250 is available in the following color wavelengths:

- Red Orange (615 nm)
- Red (623 nm)
- Long Red (630 nm)
- Super Red (635 nm)

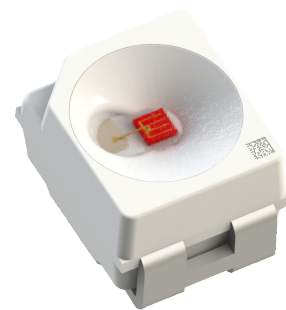
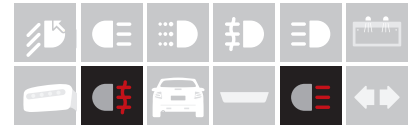

FEATURES AND BENEFITS

- Higher drive current than competition to enable increased flux performance
- Low thermal resistance for better hot lumen performance
- Standard PLCC4 package for cost efficiency and ease of production

PRIMARY APPLICATIONS

- Rear Fog
- Stop/Tail

Table of Contents

General Product Information	2
Product Test Conditions	2
Part Number Nomenclature	2
Environmental Compliance	2
Performance Characteristics	3
Product Selection Guide	3
Optical Characteristics	3
Electrical and Thermal Characteristics	3
Absolute Ratings	4
Characteristic Curves	4
Spectral Power Distribution Characteristics	4
Light Output Characteristics	5
Forward Current Characteristics	6
Radiation Pattern Characteristics	7
Operating Limits Characteristics	8
Permissible Pulse Handling Characteristics	8
Product Bin and Labeling Definitions	9
Designing with SignalSure	9
Decoding Product Bin Labeling	9
Luminous Flux Bins	10
Color Codes	11
Forward Voltage Bins	11
Mechanical Dimensions	12
Reflow Soldering Guidelines	13
JEDEC Moisture Sensitivity	13
Solder Pad Design	14
Packaging Information	15
Pocket Tape Dimensions	15
Reel Dimensions	15
Product Labeling	16

General Product Information

Product Test Conditions

SignalSure 250 LEDs are tested and binned using a 20 ms monopulse (MP) at 250 mA drive current, junction temperature, T_j , of 25 °C.

Part Number Nomenclature

Part numbers for SignalSure 250 follow the convention below:

A 1 D L – **B C C C** L 1 2 **D E F G** 0 0

Where:

- B** – designates color (O = Red Orange and S = Super Red)
- C C C** – designates minimum dominant wavelength (612 = 612 nm, 620 = 620 nm, 627 = 627 nm and 632 = 632 nm)
- D** – designates minimum flux bin (See Product Bin and Labeling section)
- E** – designates the flux bin range (3 = 3 subsequent flux bins including the minimum bin)
- F G** – designates forward voltage range in which F is the minimum V_f bin and G is the maximum V_f bin (See Product Bin and Labeling Definitions section)

Therefore, the following part number is used for a SignalSure 250 Red Orange, 612nm minimum wavelength, luminous flux range of 36 lumens to 61 lumens and forward voltage range of 2.07 V to 2.79 V:

A 1 D L – **O 6 1 2** L 1 2 **U 3 A F** 0 0

Environmental Compliance

Lumileds LLC is committed to providing environmentally friendly products to the solid-state lighting market. SignalSure 250 is compliant to the European Union directives on the restriction of hazardous substances in electronic equipment, namely the RoHS Directive 2011/65/EU and REACH Regulation (EC) 1907/2006. Lumileds LLC will not intentionally add the following restricted materials to its products: lead, mercury, cadmium, hexavalent chromium, polybrominated biphenyls (PBB) or polybrominated diphenyl ethers (PBDE).

Performance Characteristics

Product Selection Guide

Table 1. Product selection for SignalSure 250 at 20 ms MP, 250 mA, $T_j = 25\text{ °C}$

COLOR	DOMINANT WAVELENGTH ^[1,2] (nm)	PART NUMBER
Red Orange	615	A1DL - O612L
Red	623	A1DL - R620L
Long Red	630	A1DL - S627L
Super Red	635	A1DL - S632L

Notes for Table 1:

1. Dominant wavelength is derived from the CIE 1931 Chromaticity diagram and represents perceived color.
2. Lumileds maintains a tolerance of $\pm 0,5$ nm for dominant wavelength measurements.

Optical Characteristics

Table 2. Typical optical characteristics for SignalSure 250 at 20 ms MP, 250 mA, $T_j = 25\text{ °C}$

PART NUMBER	TYPICAL TOTAL INCLUDED ANGLE ^[1] $\theta_{0,90V}$	TYPICAL VIEWING ANGLE ^[2] $2\theta_{1/2}$
A1DL - O612L	140°	110°
A1DL - R620L	140°	110°
A1DL - S627L	140°	110°
A1DL - S632L	140°	110°

Notes for Table 2:

1. Total angle at which 90% of total luminous flux is captured.
2. Viewing angle is the off axis angle from lamp center line where the luminous intensity is 1/2 of the peak value.

Electrical and Thermal Characteristics

Table 3. Electrical and thermal characteristics for SignalSure 250 at 20 ms MP, 250 mA, $T_j = 25\text{ °C}$

PART NUMBER	FORWARD VOLTAGE (V)		THERMAL RESISTANCE - JUNCTION TO CASE (°C/W)			
			$R\theta_{j-c\text{ el}}$ ^[2]		$R\theta_{j-c\text{ real}}$ ^[3]	
	MINIMUM	MAXIMUM	TYPICAL	MAXIMUM ^[4]	TYPICAL	MAXIMUM ^[4]
A1DL-xxxxL12xxxxxx	2.07	2.79	22.7	25	30.2	33

Notes for Table 3:

1. All values are typical unless otherwise stated.
2. $R_{th\text{ j-c el}}$: Electrical thermal resistance (junction to case).
3. $R_{th\text{ j-c real}}$: Real thermal resistance (junction to case) with wall plug efficiency included. Reference JESD51-51, JESD51-14, 4.1.3.
4. The Max Rth values are calculated (3 σ).

Absolute Ratings

Table 4. Absolute ratings for SignalSure 250

PARAMETER	PERFORMANCE
Minimum DC Forward Current	10 mA
Maximum DC Forward Current	300 mA
Maximum Junction Temperature ^[1]	135 °C
Operating Case Temperature at Test Current ^[1]	-40 °C to 115 °C
Operating Case Temperature at Maximum Current ^[1]	-40 °C to 115 °C
Storage Temperature	-40 °C to 115 °C
Soldering Temperature	JEDEC 020E 260 °C
Allowable Reflow Cycles	3
ESD Sensitivity ^[2]	±8 kV HBM, ±2 kV CDM
Reverse Voltage (V _r) ^[3]	-10 V

Notes for 4:

1. Proper current derating must be observed to maintain junction temperature below the maximum, so that the LED is maintained below the maximum rated operating case temperature. SignalSure LEDs driven at or above the maximum rated operating case temperature may have shorter lifetime.
2. Measured using human body model (per ANSI/ESDA/JEDEC JS-001-2010) and charged device model (per JESD22-C101F).
3. SignalSure 250 is not designed to be drive in reverse bias.

Characteristic Curves

Spectral Power Distribution Characteristics

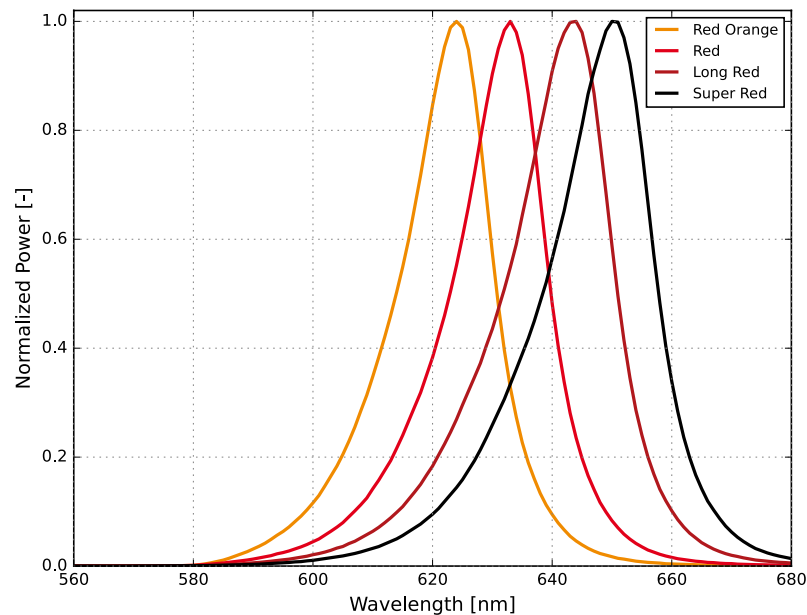

Figure 1a. Typical normalized power vs. wavelength for SignalSure 250 at 20 ms MP, 250 mA, T_j = 25 °C

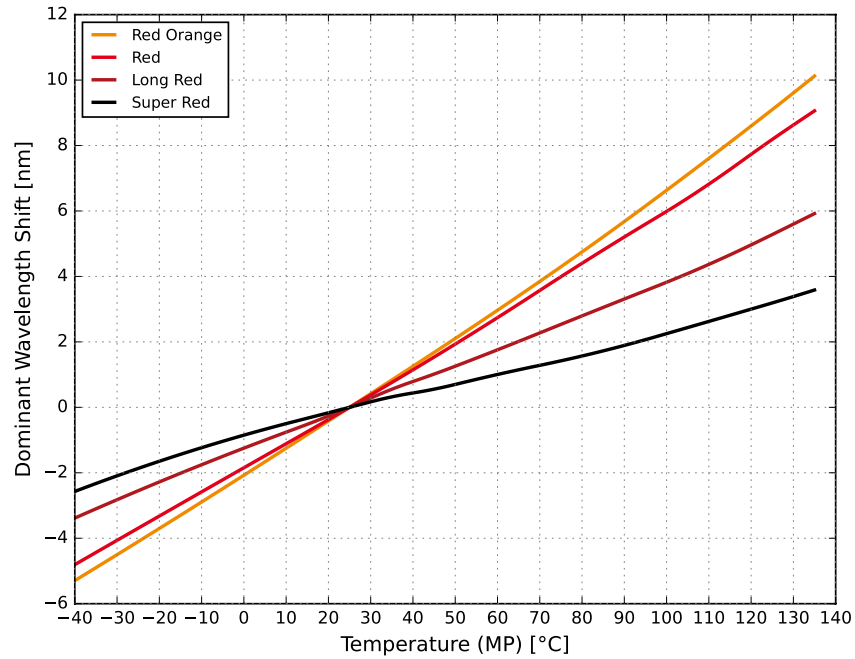

Figure 1b. Typical wavelength shift vs junction temperature for SignalSure 250 at 20 ms MP, 250 mA, $T_j = 25\text{ }^\circ\text{C}$

Light Output Characteristics

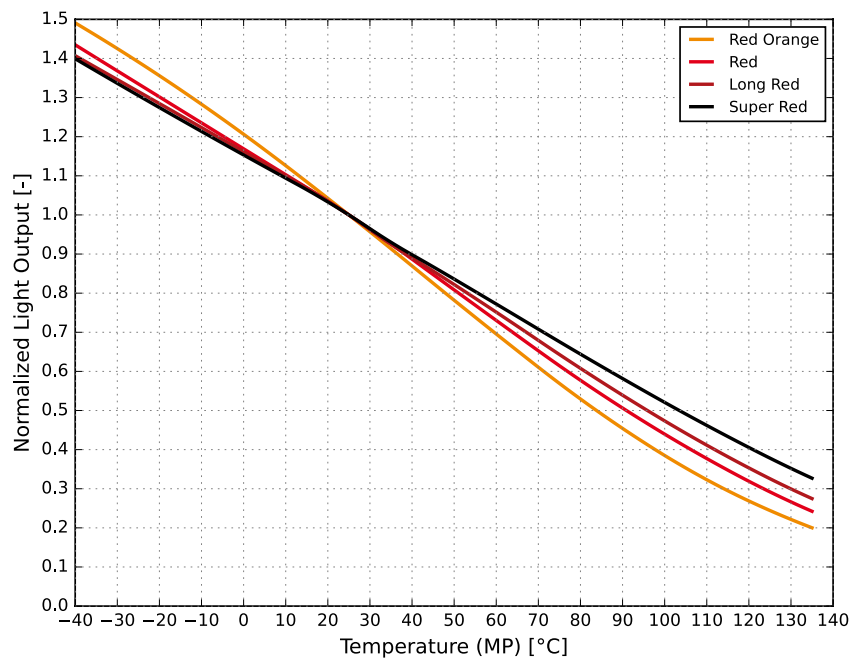

Figure 2. Typical normalized light output vs. junction temperature for SignalSure 250 at 20 ms MP, 250 mA

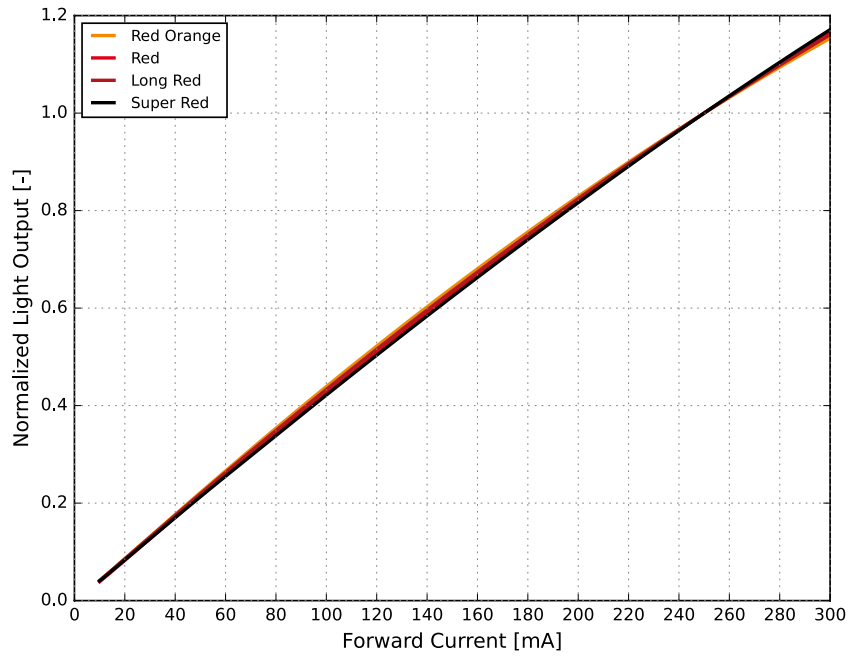

Figure 3. Typical normalized light output vs. forward current for SignalSure 250 at $T_j = 25\text{ }^\circ\text{C}$

Forward Current Characteristics

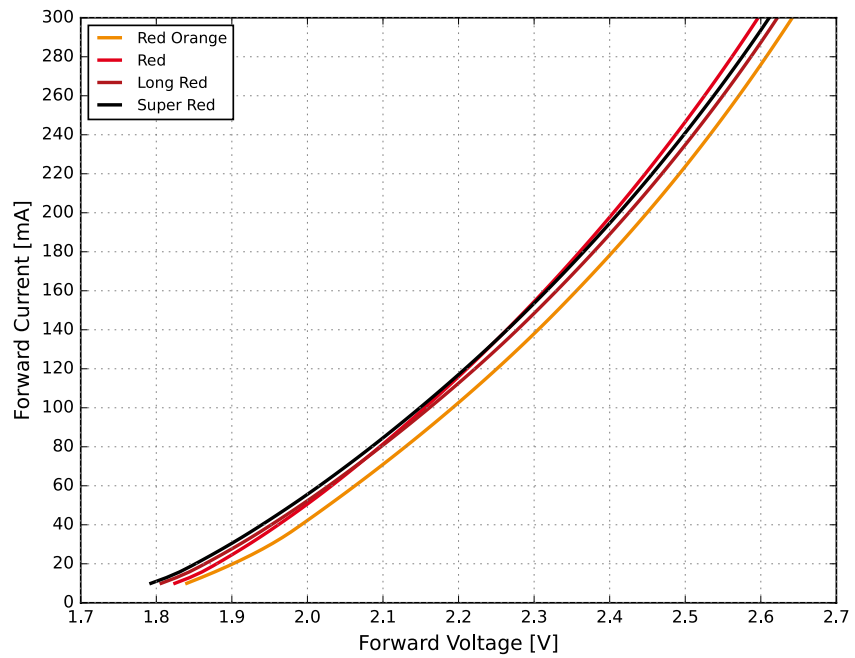

Figure 4a. Typical forward current vs. forward voltage for SignalSure 250 at $T_j = 25\text{ }^\circ\text{C}$

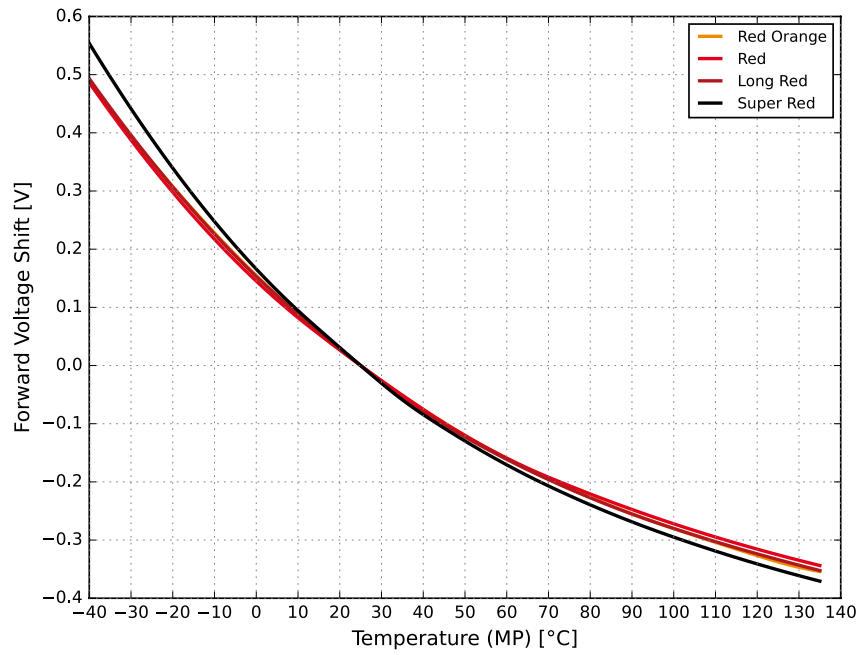

Figure 4b. Typical forward voltage shift vs. junction temperature for SignalSure 250 at 20 ms MP, specified test current

Radiation Pattern Characteristics

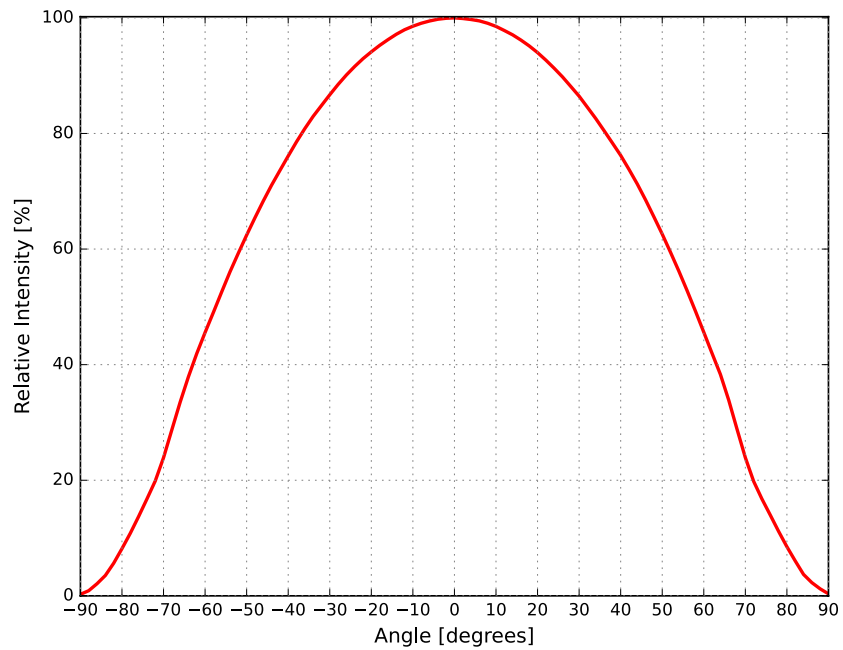

Figure 5. Typical radiation pattern for SignalSure 250 at 20 ms MP, 250 mA

Operating Limits Characteristics

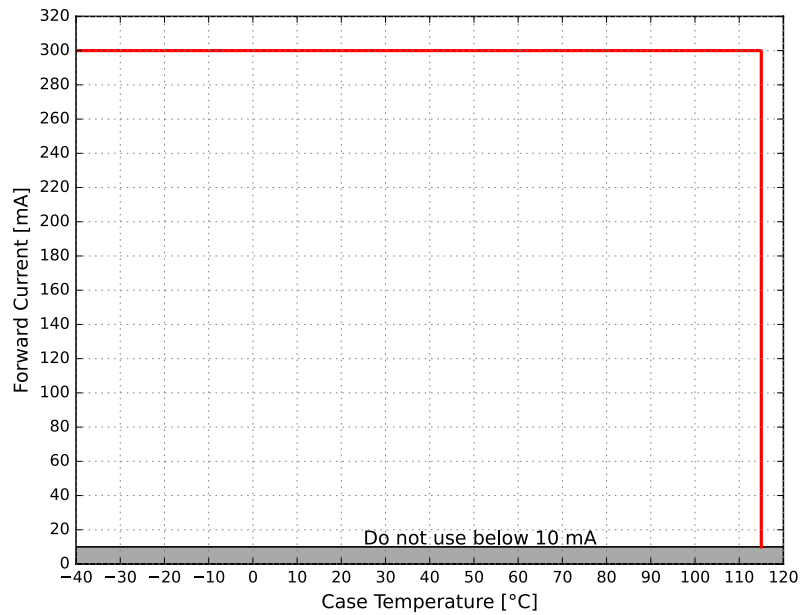

Figure 6. Maximum forward current vs. case temperature for SignalSure 250

Permissible Pulse Handling Characteristics

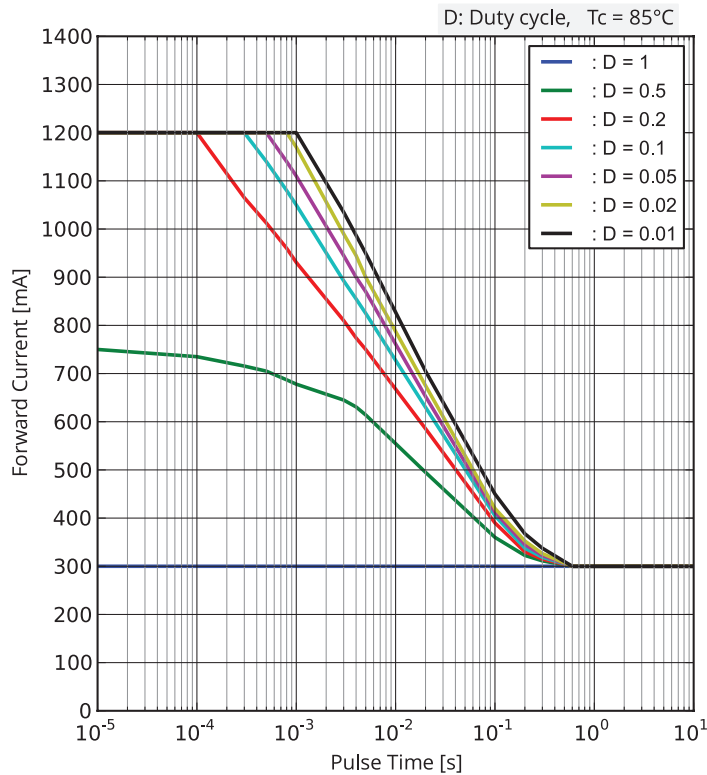

Figure 7. Permissible pulse handling capability for SignalSure 250

Product Bin and Labeling Definitions

Designing with SignalSure

Flux bins supportable for car programs depend on product color and program start- and end-of-production date. Flux roadmaps by year and product color are maintained and available from the sales representative. Please contact your local sales representative to request the flux bin range with best supportability for program timing.

Decoding Product Bin Labeling

In the manufacturing of semiconductor products, there are variations in performance around the average values given in the technical datasheets. For this reason, Lumileds bins the LED components for luminous flux, color and forward voltage.

SignalSure 250 LEDs are labeled using a 3-digit CAT code following the format below:

A B C

- A** – designates luminous flux bin (example: J = 15.0 lumens to 18.0 lumens)
- B** – designates color code (example: 3 = 612 nm to 618 nm)
- C** – designates forward voltage bin (example: B = 2.07 V to 2.19 V)

SignalSure 250 dual binned emitters are labeled using a 5-digit CAT code following the format below.

A B C D E

- A** – designates luminous flux bin at 250 mA (example: J = 15.0 lumens to 18.0 lumens)
- B** – designates luminous flux bin at 5 mA (example: G = 0.35 lumens to 0.42 lumens)
- C** – designates color code (example: 3 = 612 nm to 618 nm)
- D** – designates forward voltage bin at 250 mA (example: A = 2.07 V to 2.19 V)
- E** – designates forward voltage bin at 5 mA (example: A = 1.66 V to 1.72 V)

Luminous Flux Bins

Table 5 lists the standard luminous flux bins for SignalSure 250 emitters. Product availability in a particular bin varies by color and platform start-of-production date. Contact your local sales representative for best supportability of programs.

Table 5a. Luminous flux bin definitions for SignalSure 250 at 20 ms MP, 250 mA, $T_j = 25\text{ }^\circ\text{C}$

BIN	LUMINOUS FLUX (lm)	
	MINIMUM	MAXIMUM
J	15.0	18.0
M	18.0	21.0
N	21.0	25.0
P	25.0	30.0
R	30.0	36.0
U	36.0	43.0
W	43.0	51.0
X	51.0	61.0
Y	61.0	73.0
Z	73.0	83.0

Notes for Table 5a:

1. Lumileds maintains a tolerance of $\pm 10\%$ on luminous flux measurements.

Table 5b. Luminous flux bin definitions for SignalSure 250 at 20 ms MP, 250 mA, $T_j = 25\text{ }^\circ\text{C}$

BIN	LUMINOUS FLUX (lm)	
	MINIMUM	MAXIMUM
G	0.35	0.42
H	0.42	0.50
J	0.50	0.60
M	0.60	0.72
N	0.72	0.86
P	0.86	1.02
R	1.02	1.22
U	1.22	1.46
W	1.46	1.75

Notes for Table 5b:

1. Lumileds maintains a tolerance of $\pm 10\%$ on luminous flux measurements.
2. Applies to dual binning option only

Table 5c. Luminous flux bin definitions for SignalSure 250 at 20 ms MP, 250 mA, $T_j = 25\text{ }^\circ\text{C}$

BIN	PAIRING BIN	MINIMUM LUMINOUS FLUX (lm)	MAXIMUM LUMINOUS FLUX (lm)
250 mA		5 mA	
U	G, H, J, M, N	0.35	0.86
W	M, N, P, R, U	0.60	1.46
X	R, U, W	1.02	1.75

Notes for Table 5c:

1. Applies to dual binning option only

Color Codes

Table 6. Color code definitions for SignalSure 250 at 20 ms MP, 250 mA, $T_j = 25\text{ }^\circ\text{C}$

CODE	DOMINANT WAVELENGTH (nm)	
	MINIMUM	MAXIMUM
3	612	618
6	620	627
4	627	632
5	632	638

Notes for Table 6:

1. Lumileds maintains a tolerance of $\pm 0.5\text{ nm}$ on dominant wavelength measurements.

Forward Voltage Bins

Table 7a. Forward voltage bin definitions for SignalSure 250 at 20 ms MP, 250 mA, $T_j = 25\text{ }^\circ\text{C}$

BIN	FORWARD VOLTAGE (V_f)	
	MINIMUM	MAXIMUM
A	2.07	2.19
B	2.19	2.31
C	2.31	2.43
D	2.43	2.55
E	2.55	2.67
F	2.67	2.79

Notes for Table 7a:

1. Lumileds maintains a tolerance of $\pm 0.06\text{ V}$ on forward voltage measurements.
2. Applies to dual binning option only.

Table 7b. Forward voltage bin definitions for SignalSure 250 at 20 ms MP, 5 mA, $T_j = 25\text{ }^\circ\text{C}$

BIN	FORWARD VOLTAGE (V_f)	
	MINIMUM	MAXIMUM
A	1.66	1.72
B	1.72	1.78
C	1.78	1.84
D	1.84	1.90
E	1.90	1.96
F	1.96	2.02
G	2.02	2.08
H	2.08	2.14
J	2.14	2.20

Notes for Table 7b:

1. Lumileds maintains a tolerance of $\pm 0.06\text{ V}$ on forward voltage measurements.
2. Applies to dual binning option only.

Table 7c. Forward voltage bin paring for SignalSure 250 at 20 ms MP, 250 mA and 5 mA, $T_j = 25\text{ }^\circ\text{C}$

BIN	MINIMUM FORWARD VOLTAGE (V_f)	MAXIMUM FORWARD VOLTAGE (V_f)	PAIRING BIN	MINIMUM FORWARD VOLTAGE (V_f)	MAXIMUM FORWARD VOLTAGE (V_f)
250 MA			5mA		
A	2.07	2.19	A	1.66	1.72
B	2.19	2.31	A, B	1.66	1.78
C	2.31	2.43	A, B, C	1.66	1.84
D	2.43	2.55	A, B, C, D	1.66	1.90
E	2.55	2.67	A, B, C, D, E	1.66	1.96
F	2.67	2.79	A, B, C, D, E, F	1.66	2.02

Notes for Table 7c:

1. Lumileds maintains a tolerance of $\pm 0.06\text{ V}$ on forward voltage measurements.
2. Applies to dual binning option only.

Mechanical Dimensions

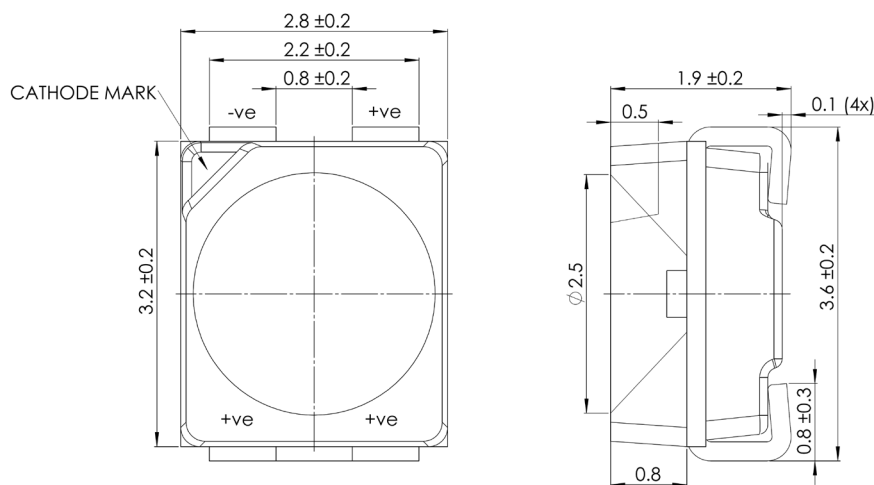

Note:
 Unless otherwise specified:
 - Dimensions are in mm
 - General Tolerance: ± 0.1

Figure 8. Mechanical dimensions for SignalSure 250

Notes for Figure 8:

1. Drawings are not to scale.
2. All dimensions are in millimeters.

Reflow Soldering Guidelines

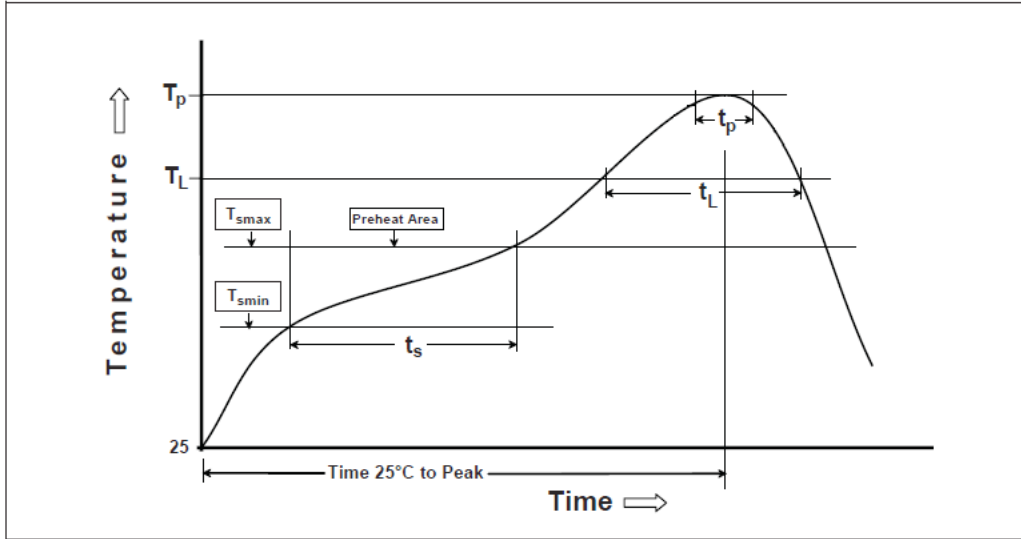

Figure 9. Visualization of the acceptable reflow temperature profile as specified in Table 8

Table 8. Reflow profile characteristics for SignalSure 250

PROFILE FEATURE	TYPICAL	MAXIMUM ACC. JEDEC J-STD-020E
Preheat Minimum Temperature (T_{smin})	150 °C	150 °C
Preheat Maximim Temperature (T_{smax})	200 °C	200 °C
Preheat Time (t_{smin} to t_{smax})	100 seconds	60 to 120 seconds
Ramp-Up Rate (T_L to T_p)	2 °C / second	3 °C/second
Liquidous Temperature (T_L)	217 °C	217 °C
Time Maintained Above Temperature T_L (t_L)	60 seconds	120 to 150 seconds
Peak / Classification Temperature (T_p)	240 °C	260 °C
Time Within 5 °C of Actual Peak Temperature (t_p)	30 seconds	30 to 40 seconds
Ramp-Down Rate (T_p to T_L)	2.5 °C / second	6 °C/second
Time 25 °C to Peak Temperature	310 seconds	480 seconds

Notes for Table 8:

1. All temperatures refer to the application Printed Circuit Board (PCB), measured on the surface adjacent to the package body.

JEDEC Moisture Sensitivity

Table 9. Moisture sensitivity levels for SignalSure 250

LEVEL	FLOOR LIFE ⁽¹⁾		SOAK REQUIREMENTS STANDARD	
	TIME	CONDITIONS	TIME	CONDITIONS
2	1 Year	≤30 °C / 60% RH	168 Hours +5 / -0	85 °C / 60% RH

Notes for Table 9:

1. Shelf life 2 years.

Solder Pad Design

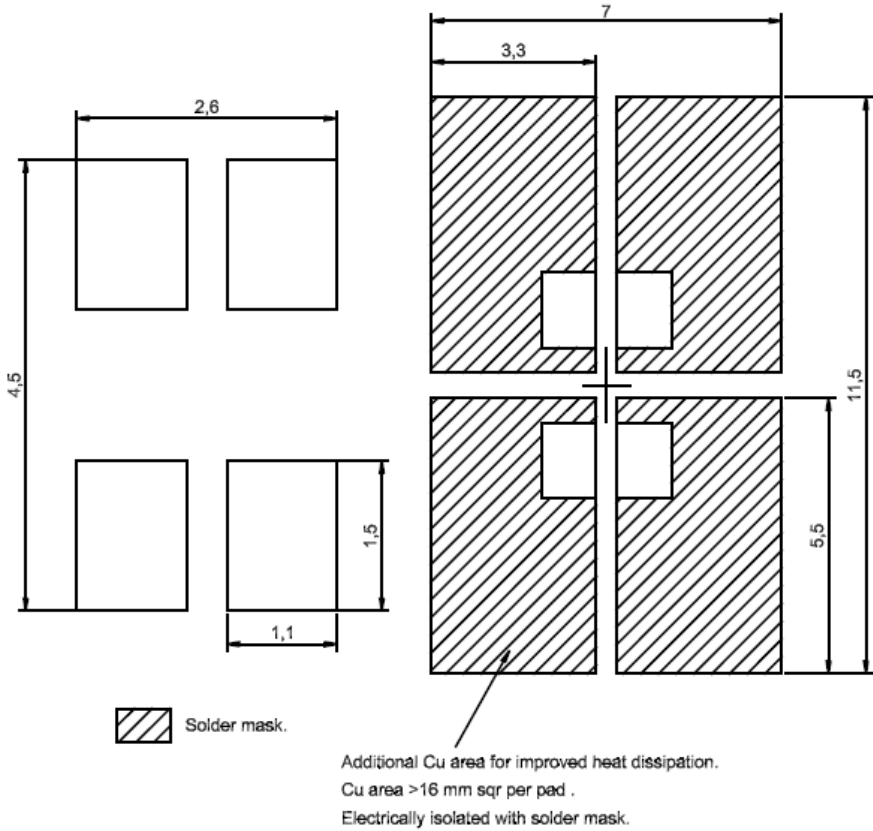

Figure 10. Recommended solder pad layout for SignalSure 250

- Notes for Figure 10:
1. The drawing shows the recommended SignalSure 250 layout on Printed Circuit Board (PCB).
 2. All dimensions are in millimeters.

Product Labeling

SignalSure 250 LEDs are packaged in moisture barrier bags on reels. Both moisture barrier bag and reels have printed information providing part numbers with CAT codes that indicate luminous flux bin, color bins and forward voltage bins.

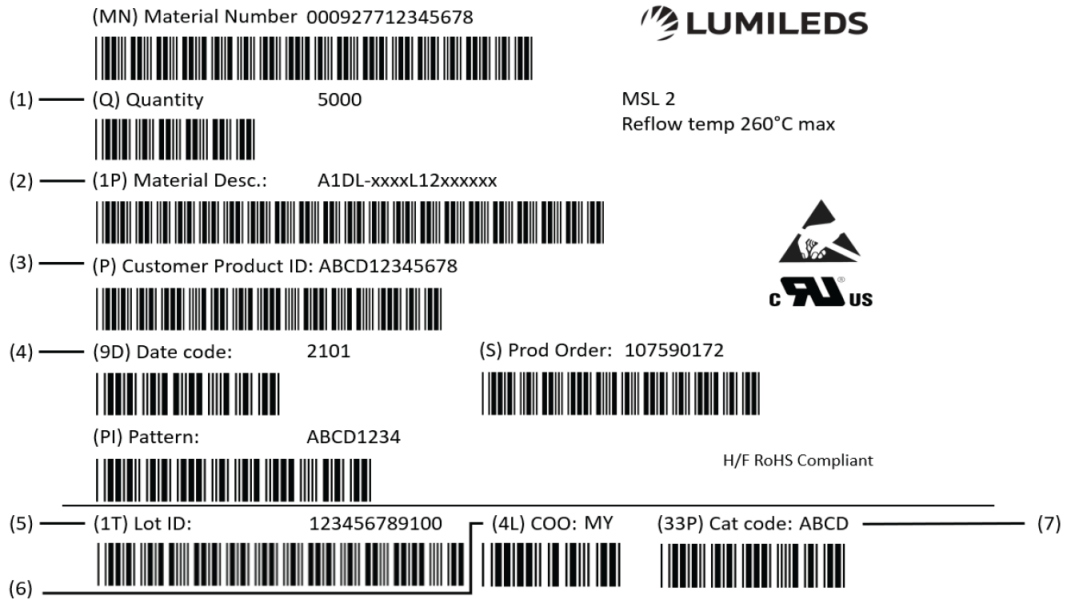

Figure 13. Example of a moisture barrier bag label

Notes for Figure 13 – Reel label descriptions for customer use:

Field labels not described are for Lumileds internal use only.

1. Total number of LED emitters in a shipment box.
2. Lumileds part number
3. Customer part number for custom requests only.
4. LED test date in YYWW format.
5. Unique product lot identification number. This number is required for traceability purposes.
6. Country code of origin of manufacturing of part (e.g. MY for Malaysia, CN for China) according to ISO 3166-1 alpha-2 document.
7. Product bin 4-digit alphanumeric CAT code.

About Lumileds

Companies developing automotive, mobile, IoT and illumination lighting applications need a partner who can collaborate with them to push the boundaries of light. With over 100 years of inventions and industry firsts, Lumileds is a global lighting solutions company that helps customers around the world deliver differentiated solutions to gain and maintain a competitive edge. As the inventor of Xenon technology, a pioneer in halogen lighting and the leader in high performance LEDs, Lumileds builds innovation, quality and reliability into its technology, products and every customer engagement. Together with its customers, Lumileds is making the world safer, better and more beautiful—with light.

To learn more about our lighting solutions, visit lumileds.com.



©2022 Lumileds Holding B.V. All rights reserved.
LUXEON is a registered trademark of the Lumileds
Holding B.V. in the United States and other countries.

lumileds.com

Neither Lumileds Holding B.V. nor its affiliates shall be liable for any kind of loss of data or any other damages, direct, indirect or consequential, resulting from the use of the provided information and data. Although Lumileds Holding B.V. and/or its affiliates have attempted to provide the most accurate information and data, the materials and services information and data are provided "as is," and neither Lumileds Holding B.V. nor its affiliates warrants or guarantees the contents and correctness of the provided information and data. Lumileds Holding B.V. and its affiliates reserve the right to make changes without notice. You as user agree to this disclaimer and user agreement with the download or use of the provided materials, information and data. A listing of Lumileds product/patent coverage may be accessed at lumileds.com/patents.